

# SHORT-WAVE ADAPTER USES ANALYZED

April 5  
1930

10 Cents  
Per Copy

Bewildering Simplicity  
of Non-Reactive AF

# RADIO

REG. U.S. PAT. OFF.

# WORLD

419th Consecutive Issue—NINTH YEAR

Debate on Dynamics  
Versus Magnetics

Jansky's Clinical Study  
of Proximate Interference

## SIX-CIRCUIT TUNER UNDER TEST

*See Article on Pages 5, 6 and 7*

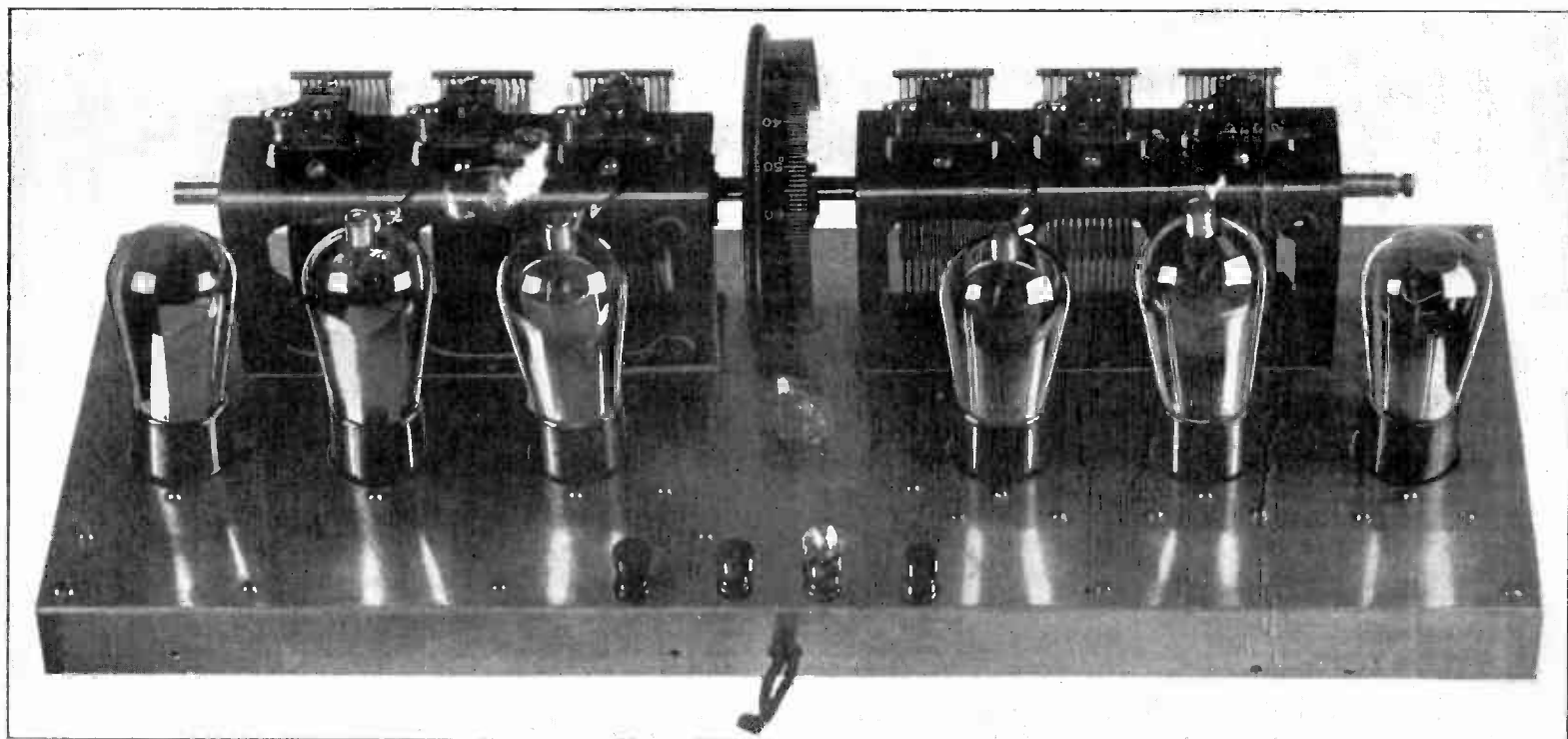

View of Six-Circuit Tuner With One Stage of Audio

## AN EXTRA-GOOD A ELIMINATOR

# The Latest in Tuning Equipment

## SHIELDED COIL

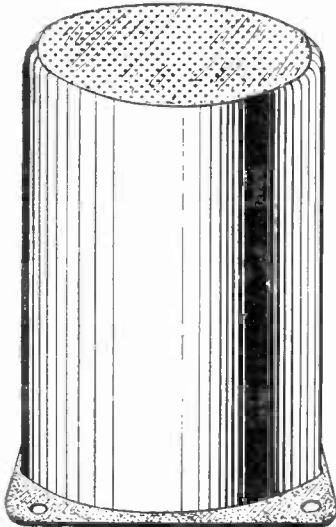

RF transformer in aluminum shield 3 1/4" square at bottom, 3 1/4" high. If metal sub-panel is used no extra base is needed. Coils have brackets on. You must assemble in shield yourself and solder winding terminals to built-in lugs. For all circuits and stages, including screen grid tubes.  
 Cat. No. SH3 for .00035 mfd. ....\$0.95  
 Cat. No. SH5 for .0005 mfd. ....\$1.00  
 Cat. SHB (extra base) .....\$0.10

## BERNARD TWO-TUBE TUNER ASSEMBLY

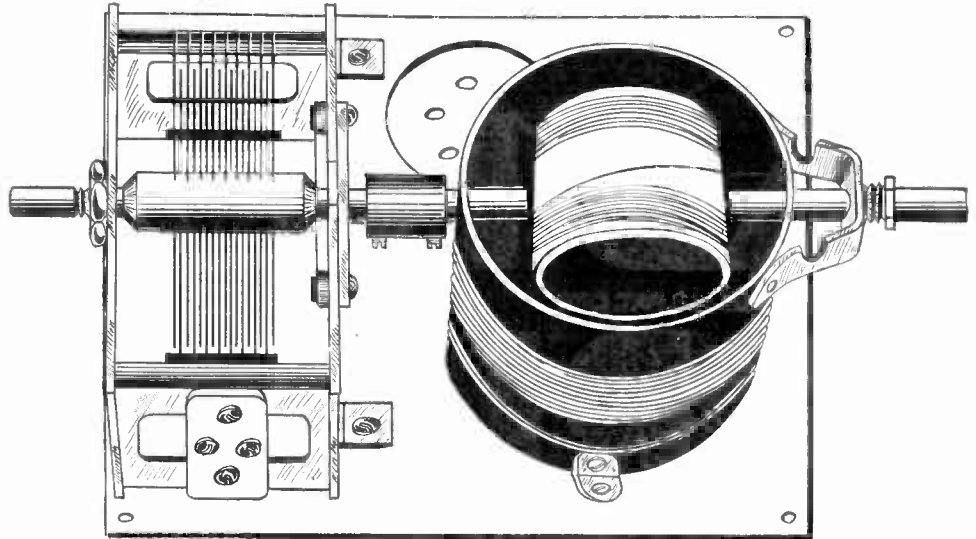

For building a tuner consisting of a stage of screen grid radio frequency amplification and a detector, AC or battery-operated, use the Bernard two-tube tuner assembly. Suitable for single control with one drum dial or separately tuned stages with two flat-type dials. The assembly consists of antenna stage (BTL-AC or BTL-DC), having Bernard Tuner BT3A, a .00035 mfd. condenser, socket, link and aluminum base. The detector input stage (BTR-AC or BTR-DC) consists of the same parts, but the coil has a tuned primary with untuned input to detector. Assemblies are unwired but are erected.  
 The condenser has shaft protruding at rear, so if two dials are used coil is put at front panel in either instance and condenser at front panel for the other.  
 For AC operation, 224 RF and 224, 227 or 228 detector, order Cat. No. BTL-AC and BTR-AC at \$6.00 for both.  
 For battery operation of filaments, 223 RF and 223, 240, 201A or 112A detector, order Cat. No. BTL-DC and BTR-DC at \$6.00 for both.  
 [Note: for drum dial single control an 80 mmfd. equalizing condenser is necessary. This is extra at \$0.35. Order Cat. EQ-80.]

## ANTENNA COUPLER

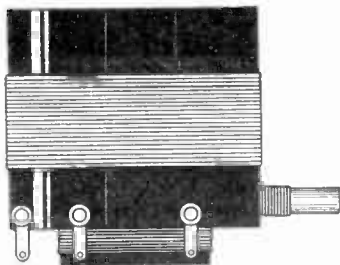

Cat. No. VA5—\$0.85  
**FOR .0005 MFD. CONDENSER**  
 Moving primary and fixed secondary, for antenna coupling. Serves as volume control.  
 Cat. No. VA3 for .00035 mfd. ....\$0.90

## BERNARD TUNERS

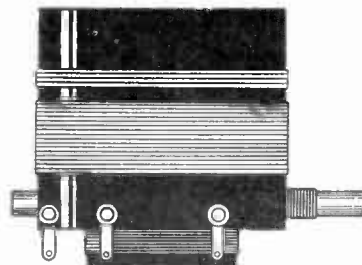

Cat. No. BT3A—\$1.35  
**FOR .0005 MFD. CONDENSERS**

Bernard Tuner BT3A for .0005 mfd. for antenna coupling, the primary being fixed and the secondary tuned. This coil is used as input to the first screen grid radio frequency tube. Secondary has moving coil.  
 Cat. No. BT3A for .00035 mfd. ..\$1.35  
 Bernard Tuner BT3B for .0005 mfd. for working out of a screen grid tube, tuned primary, untuned secondary. Primary has moving coil.  
 Cat. No. BT3B for .00035 mfd. ..\$1.35

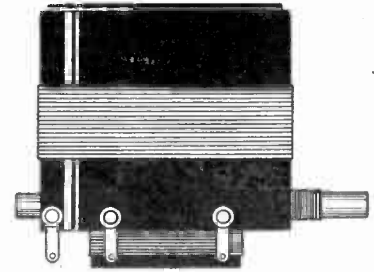

Cat. No. BT3B—\$1.35  
**FOR .0005 MFD. CONDENSER**

## SG TRANSFORMER

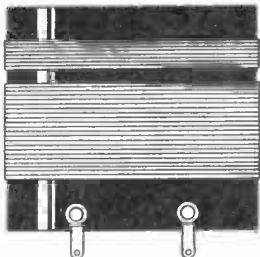

Cat. No. SGS5—\$0.60  
**FOR .0005 MFD. CONDENSER**  
 Interstage radio frequency transformer, to work out of a screen grid tube, primary untuned.  
 Cat. No. SGS3 for .00035 mfd. ....\$0.65

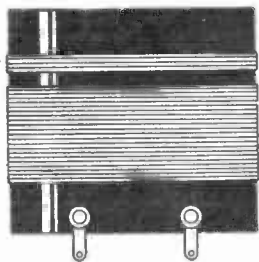

Cat. No. RF5—\$0.60  
**FOR .0005 MFD. CONDENSER**

## DIAMOND PAIR

Cat. No. RF5—\$0.60  
**FOR .0005 MFD. CONDENSER**  
 Antenna coil for any standard circuit, and one of the two coils constituting the Diamond Pair.  
 Cat. No. RF3 for .00035 mfd. ....\$0.65  
 Cat. No. SGT5—\$0.85  
**FOR .0005 MFD. CONDENSER**  
 Interstage 3-circuit coil for any hookup where an untuned primary is in the plate circuit of a screen grid tube.  
 SGT3 for .00035 mfd. ....\$0.90

Order the Diamond Pair, Cat. DP5 for .0005 mfd. at .....\$1.45  
 Order the Diamond Pair, Cat. DP3 for .00035 mfd. at .....\$1.55  
 [Note: These same coils are for AC or battery circuit.]

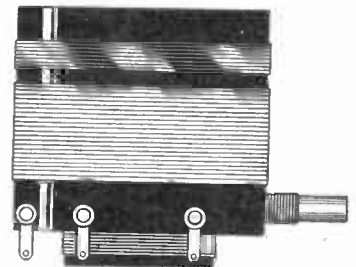

Cat. No. SGT5—\$0.85  
**FOR .0005 MFD. CONDENSER**

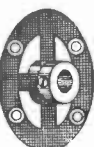

FL4 \$0.30  
 Flexible insulated coupler for untuning coil or condenser shafts.  
 Order Cat. FL4 at .....\$0.30  
 Equalizing condenser, 80 mmfd., for connection across any tuning condenser where ganging is resorted to, or for equalizing independently tuned circuits to make dials track.  
 Order Cat. EQ80 at .....\$0.35

The standard three-circuit tuner is used with primary in the plate circuit of any RF tube, AC or battery type, excepting only screen grid tube.  
 For .0005 mfd. order T5 at .....\$0.85  
 For .00035 mfd. order Cat. T3 at .....\$0.90  
 All coils have 2 1/4" diameter, except the shielded coil, which is wound on 1 1/4".  
 The coils are wound by machine on a bakelite form, and the tuned windings have identical inductance for a given capacity condenser, i. e., .0005 mfd. or .00035 mfd. Full coverage of the wave band is assured.  
 All coils with a moving coil have single hole panel mounting fixture. All others have base mounting provision. The coils should be used with connection lugs at bottom, to shorten leads.  
 Only the Bernard Tuners have a shaft extending from rear. This feature is necessary so that physical coupling to tuning condenser shaft may be accomplished by the insulated link.

## STANDARD TUNER

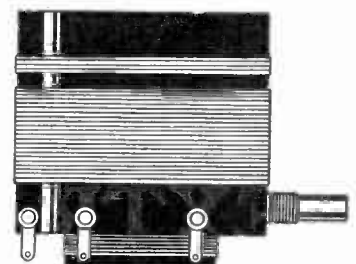

Screen Grid Coil Company,  
 143 West 45th Street,  
 New York, N. Y. (Just East of Broadway.)

Please ship at once C. O. D.:

Cat. No. .... at \$ .....

Cat. No. .... at \$ .....

Cat. No. .... at \$ .....

Name .....

Address .....

City ..... State .....

# The Most Complete Radio Book Service!

Your Opportunity to Obtain Any of the Outstanding Volumes from One Source

## "AUDIO POWER AMPLIFIERS"

By J. E. Anderson, M.A., and Herman Bernard, LL.B.

The First and Only Book On This Important Subject

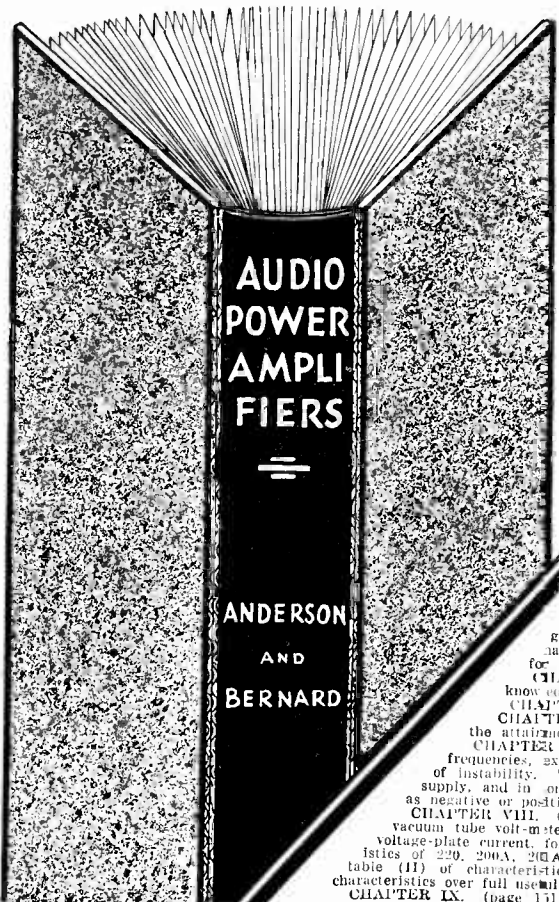

IN radio receivers, separate audio amplifiers, talking movies, public address systems and the like, the power amplifier stands out as of predominant importance, therefore a full and authentic knowledge of these systems is imperative to every technician. "Audio Power Amplifiers" is the book that presents this subject thoroughly. The authors are:

J. E. Anderson, M.A., former instructor in physics, University of Wisconsin, former Western Electric engineer, and for the last three years technical editor of "Radio World."  
Herman Bernard, LL.B., managing editor of "Radio World."

They have gathered together the far-flung branches of their chosen subject, treated them judiciously and authoritatively, and produced a volume that will clear up the mysteries that have perplexed many. The book begins with an elementary exposition of the historical development and circuit constitution of audio amplifiers and sources of power. From this simple start it quickly proceeds to a well-considered exposition of circuit laws, including Ohm's laws and Kirchhoff's laws. The determination of resistance values to produce required voltages is carefully expounded. All types of power amplifiers are used as examples: AC, DC, battery operated and composite. But the book treats of AC power amplifiers most generously, due to the superior importance of such power amplifiers commercially.

"Audio Power Amplifiers" is for those who know something about radio. It is not for novices. But the engineers of manufacturers of radio receivers, power amplifiers, sound installations in theatres, public address systems and phonograph pickups, will welcome this book. Engineers—even chief engineers—of the Bell Telephone Laboratories, Radio Corporation of America, Westinghouse Electric & Mfg. Co., Western Electric, Photophone, Vitaphone and the like needn't be afraid they won't learn something from this little book.

### Details of Chapter Contents

- CHAPTER I. (page 1) General Principles, analyzes the four types of power amplifiers, AC, DC, battery-operated and composite, illustrates them in functional blocks and schematic diagrams, and treats each branch in clear textual exposition.
- CHAPTER II. (page 20) Circuit Laws, expounds and applies Ohm's laws and their special form known as Kirchhoff's Laws.
- CHAPTER III. (page 35) Principles of Rectification, expounds the vacuum tube, both filament and gasous types, electrolytic and contact rectifiers, and explains why and how they work. Full-wave and half-wave rectification are treated, with current flow and voltage derivation analysis. Regulation curves for the 250 tube are given. Voltage division, filtration and stabilization are fully illustrated and dissected.
- CHAPTER IV. (page 62) Practical Voltage Adjustments, gives the experimental use of the theoretical knowledge previously imparted. Determination of resistance values is carefully revealed.
- CHAPTER V. (page 72) Methods of Obtaining Grid Bias, enumerates them, and compares them.
- CHAPTER VI. (page 90) Principles of Push-Pull Amplifier, defines the push-pull relationship, with keys to the attainment of desired electrical symmetry.
- CHAPTER VII. (page 98) Oscillation in Audio Amplifiers, deals with motorboating and oscillation at higher audio frequencies, explaining why it is present, stating remedies and giving expressions for pre-determination of regions of instability. The trouble is definitely assigned to the feedback through common impedance of load reactors and B supply, and in some special instances to the load's relationship to the C bias derivation as well. The feedback is shown as negative or positive and the results stated.
- CHAPTER VIII. (page 118) Characteristics of Tubes, tells how to run curves on tubes, how to build and how to use a vacuum tube volt-meter, discusses hum in tubes with AC on the filament or heaters and presents families of curves, plate voltage-plate current, for 240, 250, 201A, 112A, 171A, 227 and 245, with load lines. Also, plate voltage-plate current characteristics (11) of characteristics of Rectifier and Voltage Regulator Tubes, and individual tables, giving grid voltage, plate current characteristics over full useful voltage ranges for the 250, 201A, 112A, 171A, 227, 240, 227, 245 and 224.
- CHAPTER IX. (page 151) Reproduction of Recordings, states compiling methods and shows circuits for best connections.
- CHAPTER X. (page 161) Power Detection, explains what it is, when it should be used, and how to use it. A rectifying detector, designed by one of the authors, is expounded also.
- CHAPTER XI. (page 121) Practical Power Amplifier, gives AC circuits and shows the design of a sound reproduction system for theatres. A page is devoted to power amplifier symbols.
- CHAPTER XII. (page 183) Measurements and Testing, discloses methods of qualitative and quantitative analysis of power amplifier performance. Order Cat. APAM.

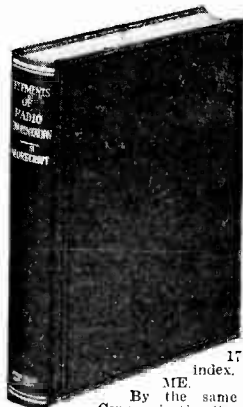

### "Elements of Radio Communication"

The latest book by Prof. John H. Morecroft, of the Engineering Department of Columbia University, and past president of the Institute of Radio Engineers, is his "Elements of Radio Communication." We regard this as the best elementary book to inform you authoritatively on the technical phases of radio in plain language, provided you have some foundation knowledge of radio. The book is a complete course on the elements of radio, containing much material never before published. It has 226 pages, 170 illustrations and a complete index. Cloth bound. Order Cat. ME.

By the same author: "Principles of Radio Communication," second edition. This book is for advanced students. It is the standard of excellence in its field. Cloth bound. Order Cat. M.

### "Radio Receiving Tubes"

The need for an up-to-date book on radio tubes that answers all the important questions has been filled by James A. Moyer, Director of University Extension, Massachusetts Department of Education, and John F. Wostrel, instructor in radio engineering, Division of University Extension, Massachusetts Department of Education. This book is a complete discussion of tube principles, functions and uses. The essential principles underlying the operation of vacuum tubes are explained in as non-technical a manner as is consistent with accuracy. The book covers the construction, action, reactivation testing and use of vacuum tubes as well as specifications for vacuum tubes and applications for distant control of industrial processes and precision measurements. 297 pages, cloth bound. Order Cat. MWT.

By the same authors:  
"Practical Radio" including the testing of radio receiving sets. 378 pages, 223 illustrations. Cloth bound. Order Cat. MWPR.  
"Practical Radio Construction and Repairing," 319 pages, a companion volume, new second edition. Order Cat. MWPRC.

(NOTE: The standard book on tubes for advanced students is "The Thermionic Vacuum Tube," by Hendrik Van der Bijl. Order Cat. VDB.)

RADIO WORLD, the first and only national radio weekly, ninth year, publishes all the latest circuits and news of radio. Its technical presentations are highly authoritative. Construction of ultra-sensitive and selective circuits is featured regularly. Subscribe for RADIO WORLD and follow the developments on pentodes, Loftin-White amplifiers, band pass filters, pre-tuners, Superheterodynes, screen grid tubes, push-pull, etc.

### Two Other New Books by the Same Authors

"The Superheterodyne," a new volume, deals with the theory and practice of this receiver in a detailed and pertinent manner. Fully illustrated. The theoretical discussion proceeds to a receiver embodying the theory stated. Full constructional data. Order Cat. ABSH.  
"Foothold on Radio," for the sheer novice, the only book published that is really for the person who knows nothing about radio. Fully understandable by any one. Freely illustrated. Order Cat. FOR.

### "Trouble Shooter's Manual"—"Mathematics of Radio"

The three books by John F. Rider, Institute of Radio Engineers, are "Mathematics of Radio," "Trouble Shooter's Manual," and "Treatise on Testing Units for Service Men."

"Mathematics of Radio," 128 pages, 8 1/2 x 11", 119 illustrations, bridges the gap between the novice and the college professor. It gives a theoretical background so necessary for a proper understanding of radio and audio circuits and their servicing. Flexible cover. Order Cat. MOR.

The first comprehensive volume devoted exclusively to the topic uppermost in every service man's mind is "Trouble Shooter's Manual," just published. It is not only a treatise for service men, telling them how to overcome their most serious problems, and fully diagramming the solutions, but it is a course in how to become a service man. It gives all the details of servicing as they have never been given before. Finding the right mode of attack, applying the remedy promptly and obtaining the actual factory-drawn diagrams of receivers always have been a hindrance on the service man's chest. But no more.

This book is worth hundreds of dollars to any one who shoots trouble in receivers—whether they be factory-made, custom-built or home-made receivers.

MORE THAN 100 WIRING DIAGRAMS OF RECEIVERS MADE BY MORE THAN FORTY DIFFERENT SET MANUFACTURERS ARE PUBLISHED IN THIS BOOK, INCLUDING OLD MODELS AND LATEST MODELS! RCA, ATWATER KENT, CROSBLEY, MAJESTIC, ZENITH, STROMBERG CARLSON, KOLSTER, FEDERAL, PANDA, ETC. 240 pages, size 8 1/2 x 11", 200 illustrations. Imitation leather cover. Order Cat. TSM.

"Treatise on Testing Units for Service Men" is a 43-page, liberally illustrated book on testing units and should have and how to use it most effectively and quickly. Order Cat. TTU.

### Other Books

- "ABC of Television," by Raymond Francis Yates, tells the whole story and gives data on construction of a television receiver. 210 pages, 100 illustrations. Cloth bound. Order Cat. TEL.
- "The Radio Manual," by G. E. Stealing of U. S. Dept. of Commerce and Robt. S. Kucse, formerly technical editor of QST. Nearly 900 pages, 369 illustrations. Bound in flexible tabuloid. Order Cat. MAN.
- "Drake's Encyclopedia," new edition, 2 1/2" thick, weigh 3 1/2 lbs., 920 pages, 1,025 illustrations. Order Cat. DRA.
- "Experimental Radio," by R. R. Ramsey, Ph.D., Prof. Physics, Indiana University. 255 pages, 168 illustrations. Cloth cover. Order Cat. REX.
- "Fundamentals of Radio," by Ramsey, 372 pages, 402 illustrations. Order Cat. RFM.
- "Principles of Radio," by Keith Henney, M.A., director, laboratory, Radio Broadcast, 47 pages, 305 illustrations. Order Cat. PIK.
- "Radio Telegraphy and Telephony," by Rudolph L. Duncan and Charles E. Drew, of Radio Institute of America. Order Cat. RTT.
- "The Superheterodyne," by R. E. Larault, 93 pages, 68 illustrations; cloth cover. Order Cat. REL.

Radio World, 145 West 45th Street, New York, N. Y. (Just East of Broadway.—Phone BRyant 0558.)

Enclosed please find \$..... for which please enter my subscription for RADIO WORLD for specified period and send free (postpaid) the one premium book designated by my cross in square.

<input type="checkbox"/> REL	\$1.00 for 8 weeks (8 issues)	<input type="checkbox"/> TTU	
<input type="checkbox"/> TSM	\$2.00 for 16 weeks (16 issues)	<input type="checkbox"/> M	
<input type="checkbox"/> FOR	\$3.00 for 6 months (26 issues)	<input type="checkbox"/> MWPR	
<input type="checkbox"/> MOR	\$4.00 for 34 weeks (34 issues)	<input type="checkbox"/> MWPRC	
<input type="checkbox"/> MWT	\$5.00 for 42 weeks (42 issues)	<input type="checkbox"/> M	
<input type="checkbox"/> MWT	\$5.00 for 42 weeks (42 issues)	<input type="checkbox"/> MWPR	
<input type="checkbox"/> APAM	\$6.00 for 1 year (52 issues)	<input type="checkbox"/> M	
<input type="checkbox"/> TEL	<input type="checkbox"/> TSM	<input type="checkbox"/> PIK	
<input type="checkbox"/> TEL	<input type="checkbox"/> REX	<input type="checkbox"/> RTT	
<input type="checkbox"/> RFM	\$7.00 for 60 weeks (60 issues)		
<input type="checkbox"/> VDB	\$10.00 for 85 weeks (85 issues)		
<input type="checkbox"/> MAN	\$12.00 for 2 years (104 issues)		

Name.....  
Address.....  
City..... State.....

# A Substantial Four-Gang Condenser

for

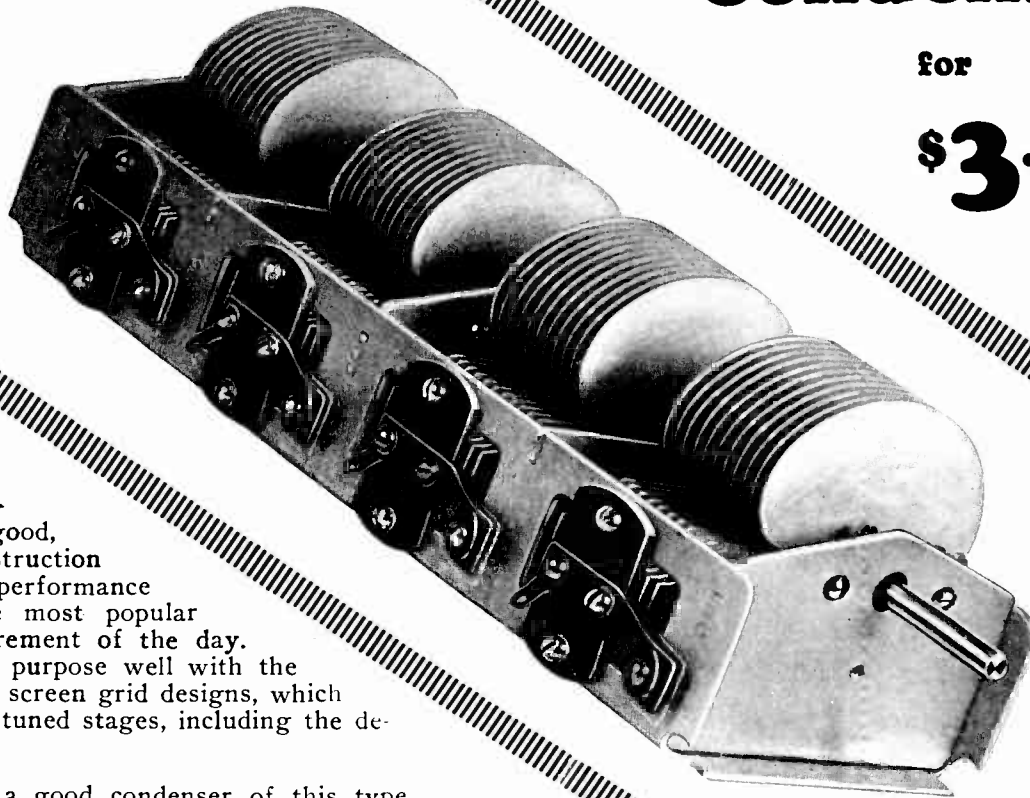
**\$3.95**

**A** FOUR-GANG CONDENSER of good, sturdy construction and reliable performance fits into the most popular tuning requirement of the day. It serves its purpose well with the most popular screen grid designs, which call for four tuned stages, including the detector input.

Ordinarily a good condenser of this type costs, at the best discount you can contrive to get, about twice as much as is charged for the one illustrated **and even then the trimming condensers are not included.** The question then arises, has quality been sacrificed to meet a price? As a reply, read the twenty-six points of advantage. The first consideration was to build quality into the condenser.

The reason for the low price is that the condenser was manufactured in very large quantities and is sold to the consumer with only one handling between factory and him, at a price only 10% above the cost of production.

All claims are backed up by our guaranty—**MONEY BACK IF IN FIVE DAYS AFTER RECEIPT OF CONDENSER YOU ARE NOT COMPLETELY SATISFIED.**

The Capacity is .00035 mfd. for each section. We haven't this condenser in any other capacity. The price is net to all, no matter what quantity. Order one shipped C. O. D. [Overall length is 11 inches.]

**5-DAY  
MONEY-BACK  
GUARANTY**

## 26 Points of Advantage!

*THE desirability and dependability of this condenser are attested by the following roster of features:*

- (1)—Rigid steel frame.
- (2)—Accurate mechanical alignment.
- (3)—Single steel shaft.
- (4)—Shaft supported at both ends and at the center.
- (5)—Accurate spacing of rotor and stator plates.
- (6)—Plates made of aluminum of uniform thickness.
- (7)—Stator plates shielded from each other and from external conductors.
- (8)—Each section provided with a built-in adjustable trimmer condenser.
- (9)—Steel spring bearings.
- (10)—Adjustable tension on bearings.
- (11)—Shaft and rotor plates removable.
- (12)—Low minimum capacity in each section.
- (13)—Low loss insulation between stator and rotor plates.
- (14)—Common rotor connection to steel frame.
- (15)—Each rotor attached to common shaft with two set screws.
- (16)—Exact equality of all condenser sections at all settings.
- (17)—Side and bottom mounting provisions.
- (18)—Straight line wavelength shape of plates.
- (19)—Brass soldering lug for each condenser stator section.
- (20)—Capacity increases with counter clockwise rotation of shaft.
- (21)—Capacity of each section, .00035 mfd.
- (22)—Plates cannot short.
- (23)—Easy turning shaft.
- (24)—Will last a lifetime.
- (25)—Eleven rotor and eleven stator plates in each section.
- (26)—Weight (condenser alone), 3½ lbs.

GUARANTY RADIO GOODS CO.  
143 West 45th St., New York, N. Y.  
(Just East of Broadway)

Please ship me within one day of receipt of this order one four-gang tuning condenser capacity of each section .00035 mfd., with trimmers built in, as advertised, at \$3.95. Please send C. O. D.

Name .....

Address .....

City .....

State .....



Vol. XVII, No. 3 Whole No. 419  
 April 5th, 1930  
 15c per Copy, \$6.00 per Year  
 [Entered as second-class matter, March, N. Y., under act of March, 1879.]  
 1922, at the Post Office at New York,

Latest Circuits and News  
 Technical Accuracy Second to None  
**EIGHTH YEAR**

A Weekly Paper published by Hennessy Radio Publications Corporation, from Publication Office, 145 West 45th Street, New York, N. Y. (Just East of Broadway) Telephone, BRyant 0558 and 0559

RADIO WORLD, owned and published by Hennessy Radio Publications Corporation, 145 West 45th Street, New York, N. Y. Roland Burke Hennessy, president and treasurer, 145 West 45th Street, New York, N. Y.; M. B. Hennessy, vice-president, 145 West 45th Street, New York, N. Y.; Herman Bernard, secretary, 145 West 45th Street, New York, N. Y. Roland Burke Hennessy, editor; Herman Bernard, business manager and managing editor; J. E. Anderson, technical editor.

# The Six-Circuit Tuner

Its Development Progresses Encouragingly

By Herman Bernard

Managing Editor

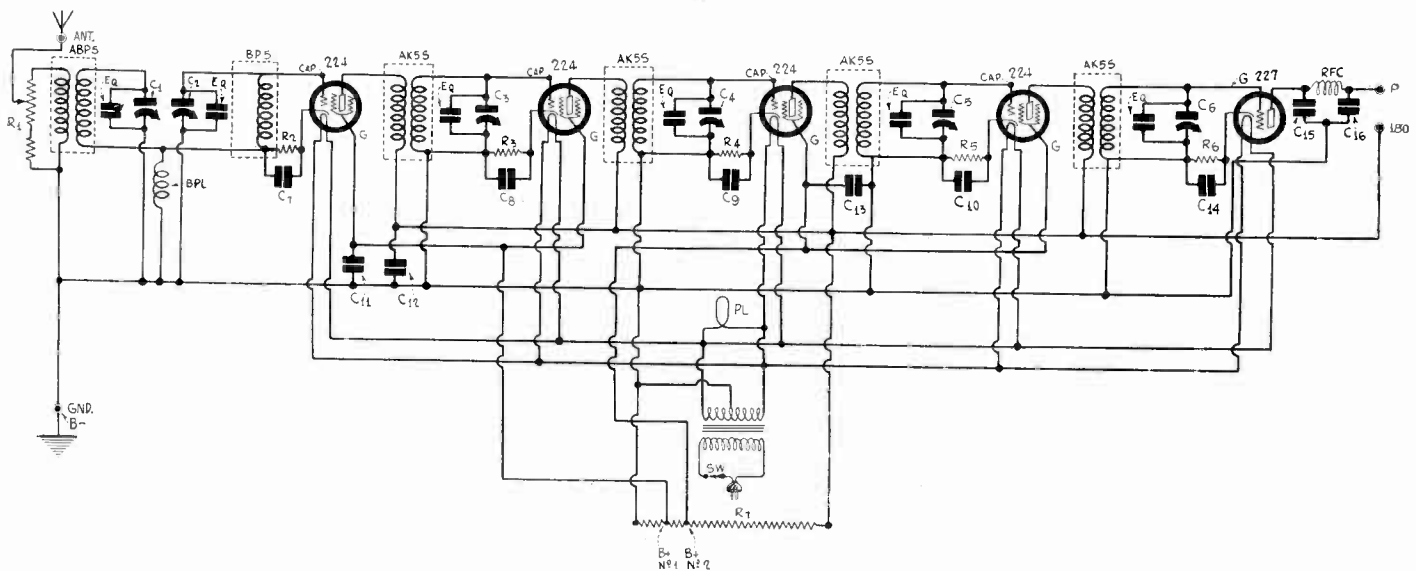

FIG. 1

DIAGRAM OF THE THEORETICAL SIX-CIRCUIT TUNER, AS PRINTED LAST WEEK. THE VOLUME CONTROL PROVED INEFFECTIVE, BECAUSE OF PICKUP IN SUBSEQUENT STAGES.

[In last week's issue, dated March 29th, was published a theoretical diagram of a tuner using six tuned circuits, for AC operation. The promise was made that the tuner would be built, and a report rendered this week. The following article constitutes the report.—EDITOR.]

AS WAS to be expected, the AC tuner, Fig. 1, discussed theoretically last week, works but its performance is not good enough to justify its duplication, for the following reasons:

- (1)—The circuit is not as selective as one would expect a six-tuned-circuit tuner to be.
- (2)—There was enough stray pickup to enable distant reception without aerial or ground.
- (3)—The screen grid voltage on the first two tubes was so critical, that oscillation resulted or very weak signals, and while it was possible to get "in between," it was too difficult.

### Remedies Exist for Troubles

There are remedies for all three troubles, in fact some single remedy applies to all three. Tests will be made again and a report rendered next week, issue of April 12th.

The diagram shown last week is republished this week as Fig. 1. Also another diagram is published, a new one, Fig. 2, showing the addition of a stage of resistance-coupled audio to the tuner, which addition will prove valuable, since distant stations then will come in with great volume. The detector biasing is more easily standardized, too, when the DC plate load is known.

As a power amplifier is to be used, anyway, it will contain two stages of audio amplification, and the stage built into the tuner will afford three stages of audio. Besides, the output is so arranged that it will feed directly into a Loftin-White power amplifier, of which there are several good commercial ones available, for instance Electrad's, or will feed into a push-pull or other power amplifier, as will be explained.

The advisability of the extra stage of audio was tested by adding it to the tuner described last week.

Now, as for remedies for difficulties encountered with the tuner, Fig. 1, and which apply to Fig. 2 as well:

Selectivity was good but not good enough. The trouble was not in the tuning condensers, for they represent as high a quality of radio product as is manufactured, nor was it in the coils, since they were wound with correct number of turns and accuracy as to spacing, as well as position of the windings in respect to each other. The fact that WTAM, Cleveland, O., and WTIC, Hartford, Conn., were among the distant stations heard in New York City without aerial or ground proved that the leads themselves acted as miniature antennas, and since the circuit is very sensitive, this pickup was enough to enable reproduction of distant stations at high volume on the speaker, when the power amplifier was used and the extra audio stage as well.

### Use of Shielding Extended

The situation calls for a shield placed over the bottom of the subpanel, so that all the wiring inside will be shielded against

# Six-Circuit Tuner Four

## Highly Sensitive Outfit Brings in DX Without

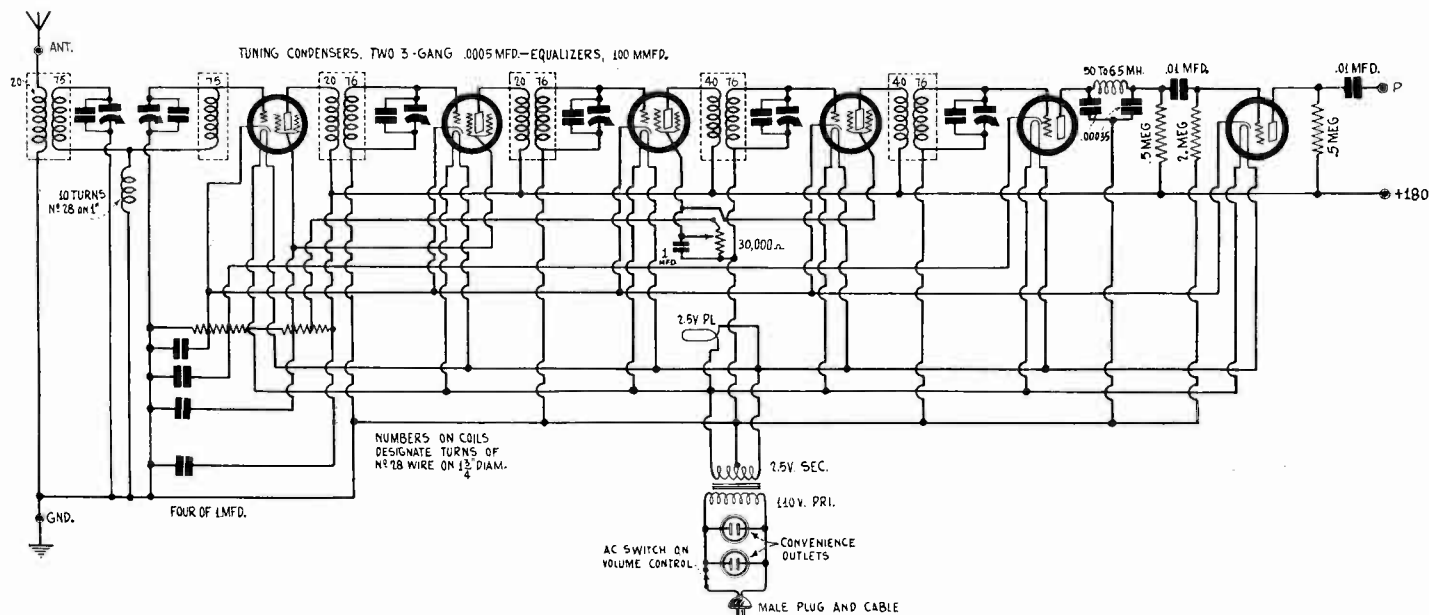

FIG. 2

REVISED DIAGRAM, SHOWING A SIX-CIRCUIT TUNER WITH A STAGE OF AUDIO ADDED, AND A FILTERED OUTPUT. A POWER AMPLIFIER OF ANY SORT, INCLUDING LOFTIN-WHITE, MAY BE CONNECTED TO P AND B—180, ALSO A PHONOGRAPH PICKUP. THE VOLUME CONTROL IS SHOWN IN A NEW POSITION, ALTHOUGH PERHAPS ONLY TEMPORARILY.

pickup of this interfering sort. Also, as an extra precaution against this condition, shielded antenna and plate leads ought to be used, no matter how short the lead may be, while any and every long lead should have the same sort of shielded wiring.

For those not familiar with this type of wire, let it be known that the wire has a rubber insulation covering, and around the rubber is a braided tube of copper or other good conducting metal. The braided surface is to be grounded by soldering to a ground bar. The braid is to be cut off  $\frac{1}{4}$  inch from the connected ends, to prevent the grounded covering from contacting with a potential that may be other than ground, for instance, B plus.

With these two precautions taken it should be almost impossible to pick up any signals without antenna connected to the aerial post, although so little as 18 inches of wire will constitute a working antenna. The tuner is that sensitive.

### More Selectivity Helps DX

It should be pointed out at once that the main trouble with multi-tube radio frequency stages today is not low sensitivity but absence of sufficient selectivity. It is true indeed that stations 20 kc apart could be separated without interference, where both stations delivered a strong signal, but from a six-circuit tuner more than that should be expected. When the selectivity is high enough the number of distant stations received increases greatly, for it is the inability adequately to discriminate among them that hinders reception of each of them at a time.

The primaries were alike, as described in last week's issue, but the critical aspect of the screen grid voltage of the first two tubes should almost disappear when the number of turns on the primaries associated with this pair of tubes is halved. Still the sensitivity should be ample. And of course the selectivity increases somewhat, as the double hump in the resonance curve, due to large primary impedance and tight coupling, becomes sharp instead.

Selectivity well may be pressed to a higher level, and without injury to quality, as the band pass filter that precedes the first tube delivers a selected frequency for amplification, so that no amplification of non-selected frequencies takes place, except by the stray pickup we are going to avoid.

### Once a Pride, Now a Disaster

It used to be a matter of pride to demonstrate a receiver that worked "without aerial or ground" connected thereto, although of course there were in fact an aerial or a group of aerials, consisting of unshielded coils that acted as loops and associated wiring that acted as capacity antennas, and ground potential as well. But the idea of superiority attaching to such a receiver disappears when one realizes that such stray pickup applies to all stages, which means that a preponderating percentage of the stray pickup is deprived of the tuning benefits of antecedent stages. Suppose wires connecting grids, screen grids and plates of the third and fourth stages of RF picked up enough energy

to make reception possible. What selection benefit would result to this energy from use of the two previous stages of amplification, with the three tuned circuits associated with them? As to this amount of pickup there would be no selection prior to the stage in which the pickup took place.

The diagram, Fig. 2, shows the same fundamental tuner with audio stage added, but the biasing voltages are taken off the voltage divider. This system worked out well, and simplified the layout and construction. What the individual resistance values should be will depend on the total resistance of the voltage divider, as the problem is one of proportioning the total resistance used. The bleeder current need not exceed 20 ma, so if 180 volts are used the total resistance would not be less than 9,000 ohms. Due to small current at the high end, much of this part is not useful for connecting points. A voltage divider with numerous taps at and around the estimated resistance values, and with a large percentage of resistance at the high end without taps, will solve the problem, for even if other voltages than 180 volts will be used for maximum, a practical voltage can be obtained even then for any purpose. The voltage division problem is still being studied, and findings will be reported soon after being made.

### Mechanical Aspect.

Regarding the mechanical layout, the tuning condensers are placed at left and right of a drum dial. As shown, the condensers are mounted on their sides. But this produces an overall height of 8 inches, whereas if the condensers were mounted on their frame base the height would come under the 7 inch limit, and thus the tuner could be put into a standard table model cabinet. For console use the 8 inch height is all right, but for the stand 7x21 inch cabinet it is not. However, the equalizing condensers, now shown on top, would have to be at front or back. If in back they would be difficult of access, as the tubes would interfere. If in front they may be adjusted before the tuner is placed in cabinet or console, which is a good plan, since it puts the trimmers out of too-easy reach. Whenever anything goes wrong with a tuner the first impulse is to readjust the equalizers, whereas they are usually about the last things to go wrong.

The shield bases are as close together now as they can go, but as there is room to share at the center, the distance between the edges of the bases can be made  $\frac{7}{16}$  inch, which will have a tendency to reduce further the critical aspect of the screen grid voltages of the first and second RF tubes.

### The Ground Bar.

A copper bar is used as ground connection. That is, instead of the subpanel being used as ground, although it, too, is grounded, the copper bar is preferred. This offers a lower resistance to the ground currents and reduces the undesired coupling between stages due to common impedance on the ground side. The bar need be no more than No. 9 copper

# and Not Selective Enough

## Aerial or Ground Attached, Which is Bad

FIG. 3

A VIEW OF THE SIX-CIRCUIT TUNER AS WIRED BY THE AUTHOR, PRIOR TO TESTS WHICH WILL BE THE BASIS OF NEXT WEEK'S ARTICLE. STRUCTURAL CHANGES WILL BE MADE. THESE WILL BE REVEALED NEXT WEEK.

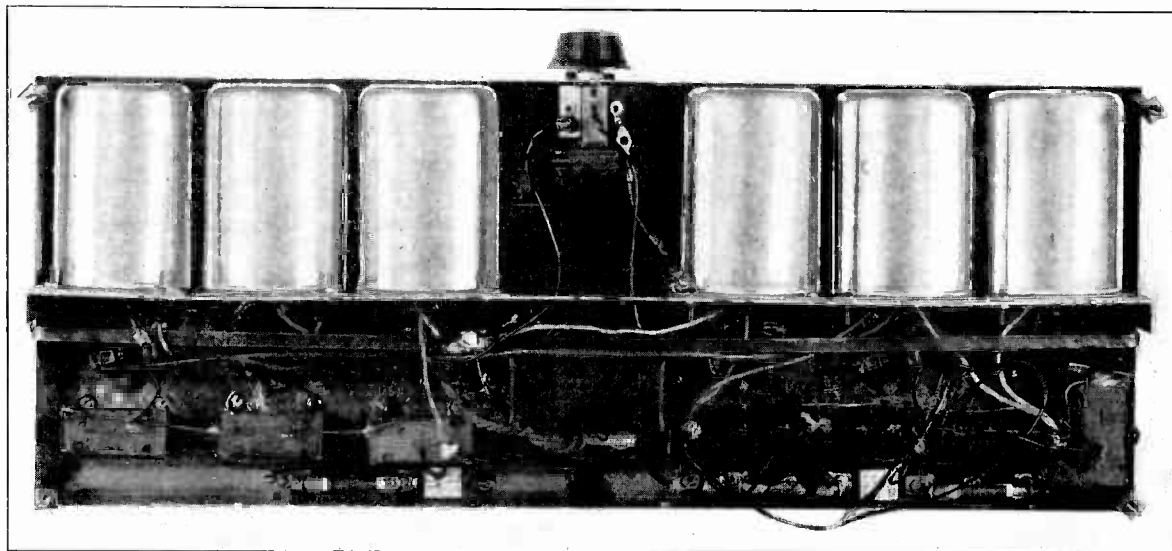

wire, although some mechanical support is added when a thicker stretch is used.

Even if the difference in resistance is only a small fraction of an ohm, this difference may be large in result where radio frequencies are concerned. Better stability actually was proved to be the case when this method of grounding was used.

The bar is connected from the ground binding post to an equivalent bar that stretches across the width of the subpanel. Then whenever a connection to ground is to be made, it goes direct to the bar, not to some other wire that ultimately goes to the bar, and not to the subpanel, either.

In such highly sensitive tuners as the type under discussion, seemingly slight differences, as in the method of grounding internal connections, assume real importance. Such a tuner is like an equilibrist on a tight rope. The slightest unbalance may prove serious.

The bar is connected to the ground binding post but placed so as to stretch across the width of the subpanel, room, to provide a means of connecting the power amplifier AC input and also, if desired, an AC dynamic speaker, at these points, whereby the single switch on the front panel will control all three.

### Windings of Coils.

The coil data this week are slightly different from those given last week, in respect to the secondaries of the RF transformers, and the impedance coil in the grid circuit of the first RF tube. The data last week enabled coverage of the scale, but the data this week, while doing no less, makes the upper

wavelength stations come in at numbers more nearly standard. The primaries are different this week, as has been noted. Now there are 20 turns on the primaries of the first three transformers and 40 on the other two.

As for the output, this is filtered, so that the P post may be connected to a Loftin-White power amplifier. The post then goes to the input cap of the screen grid tube of that amplifier. If the Loftin-White design does not use its first tube as an amplifier but as a detector, then the biasing resistor of the amplifier will have to be connected to a point on the amplifier's voltage divider more positive than the present one, and a lower value of plate resistor used in the Loftin-White amplifier.

For connection to any other amplifier, the P post of the tuner would be connected to the P post of the amplifier. This may be P on an audio transformer primary. No change need be made in the power amplifier, even though the end of that audio transformer primary goes to B plus.

A phonograph pickup could be connected to the amplifier merely by putting the pickup terminals to P and ground of the tuner. The tubes of the tuner should not be lighted then, so plug the power amplifier's AC cable plug into the light socket and do not turn on the switch of the tuner. If an AC dynamic speaker is used, this goes directly to the lamp socket or wall outlet, too, when the pickup is used.

\* \* \*

[Be sure to read the interesting report on the improved six-circuit tuner in next week's issue, dated April 12th. Notice how the trouble is carefully removed before any final design is offered to constructors.—EDITOR.]

## Favors Factory Sets

The reliability of a receiver depends largely on the ruggedness with which it has been constructed and the carefulness with which the soldering has been done. If there is much play between parts when the condensers and other adjustable parts are moved, there is danger that connections will break. Also, if unsuitable flux is used in soldering the circuit there is danger that wires will corrode and thus open a circuit. On these points the factory-made receiver is unquestionably superior. Rigidity of the chassis and ruggedness of condensers and other parts are features of commercial receivers. They are usually absent in the home-constructed set. Likewise soldering is done much better in commercial sets, because the right solder, the right flux, and in the right amounts are used. Moreover, commercial receivers are wired with flexible leads which allow much play without any danger of breaking. Many home-built receivers are still made with stiff wire which breaks easily. And in many instances dependance for permanence of connections is placed on solder alone, which breaks at the slightest provocation. Then, again, it often happens that a joint is not soldered at all but is merely smeared with a daub of dirty metal. Such thing may happen to commercial receivers, but the inspectors do not pass them. They are sent back to the wiring department for correction.

From all points of view that commercial and home-constructed receivers are compared, the commercial receiver comes out ahead.—E. Eduard Miller.

## What Pentode Can Do

It has been said that nothing can be done with a pentode that cannot be done equally with the screen grid tube. If this were true it would be equally true that nothing can be done with the screen grid tube than with the three-element tube. This is not so. Not only can a greater amplification per tube be obtained but the tube can be applied to many different circuits and uses. It is not the fault of the pentode if its inherent amplification is not utilized.

If a receiver has been designed for screen grid tubes, and pentodes are substituted, the amplification will be greater. This follows not only because the amplification factor of the pentode is greater but because the internal plate resistance is less. The load impedance designed for the screen grid tube will match the pentode better because it is most likely too small for the screen grid tube. Of course, when the pentodes are substituted the voltages should be changed and proportioned properly, and a suitable new voltage should be applied to the space charge grids. Usually a receiver that does not oscillate with screen grid tubes will oscillate with pentodes, which indicates that the amplification has been increased. Proper circuit design and placement of parts will correct the squealing.

The pentode tube will be used in the future, to be sure, but it will be used for specialized purposes for which no other tube will do quite as well. At this time such uses have not been developed. For that reason, the tube should appeal to the experimenter.—J. W. Brock.

# Best Methods of Using Mixer Type Have Greatest Applicability

By Capt. Peter

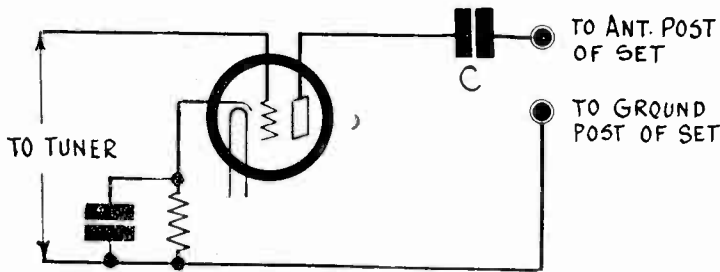

FIG. 12

THIS ILLUSTRATES A COMMON ERROR COMMITTED IN CONNECTING A SHORT WAVE ADAPTER OF THE SUPERHETERODYNE TYPE TO A BROADCAST RECEIVER. A CHOKE COIL SHOULD BE CONNECTED BETWEEN THE PLATE OF THE TUBE AND B PLUS.

EVERY short wave adapter diagram published brings in a flock of letters asking where the adapter should be plugged into a given receiver, or whether or not it can be used with this or that receiver. Sometimes these letters indicate an omission in the description of the adapter, but more frequently they indicate that the letter writers have not read the description, or that the writers only want individual attention.

#### Not All Universal.

One may write: "I saw your article on the ABC short wave adapter and it seems to me that it is just the thing that I have been looking for. I note that it can be used with all broadcast receivers. Now I have a Model 29, serial number 289,684 ABX-dyne. I am wondering whether or not the adapter can be used with this receiver." This question might be answered by paraphrasing the top sergeant's answer to a question of a similar nature relating to drill, namely, the adapter can be used with all set except Model 29, serial number 289,684 ABX-dyne. Of course, that means when stripped of military sarcasm, it can be.

Not every adapter can be used with any receiver whatsoever. For example, some adapters are designed for DC operation. If the receiver is AC operated the adapter cannot be operated by plugging in anywhere in the receiver. This, however, does not mean that the two circuits cannot be combined. It is quite possible to operate the adapter with batteries and the receiver with AC and still connect the two so that short wave signals may be received.

It is also true that if the receiver is DC operated and the adapter is designed for AC the adaptation cannot be made by plugging in. But as before, the two can be combined.

#### Legitimate Doubts.

Let us assume that all letters relating to adapters and existing receivers are justified either because of some exceptional condition or because of an omission in the article describing the adapter. One of the exceptional conditions may be that the letter writer is not familiar with radio circuits, and that he makes no pretense of any familiarity. He is perfectly justified in asking any question provided he does not refer to the serial number of his set. Let us attempt to clarify some of the problems that arise.

In the first place, if the adaptation is to be made by plugging in the adapter into one of the sockets in the receiver, the adapter and receiver must have been designed for the same kind of supply, either AC or DC. It is possible to mix the two only if a separate filament supply is used for each. Sometimes it is necessary to use separate B supplies also.

#### Sensitivity Considered.

When plug-in type adapters are used complaints of lack of sensitivity are frequent. This is particularly true when the adapter is used with modern receivers in which the detector is of the power type and when there is only one stage of audio. The owner of the adapter has been told that the proper place to plug it in is in the detector socket. The fact is that this is a highly improper place. Yet it is the only place. The necessary conclusion is that this type of adapter is unsuitable.

There are two reasons for the unsuitability. First, the power detector is not a good short wave detector; second, there is

not enough AF amplification. To make the detector effective it is necessary to provide a great deal of amplification at the high frequency, just as much as is provided in the broadcast receiver at the broadcast frequencies. Usually when an adapter is plugged into one of the receivers the set is dead as far as short wave reception is concerned.

Plug-in type of detectors that were used a few years ago are not suitable in any case, so they might as well be dismissed. The only time they give fair results is when there is a great deal of amplification after the detector. This, however, does not rule out modern type plug-in adapters, particularly those of the superheterodyne type.

#### Another Precaution.

Another precaution that should be observed in using plug-in type adapters is to see that the filament current drawn by the adapter is the same as that required by the tube normally in the socket used. This raises no problem when the adapter contains only one tube because then the filament current will be the same. When the adapter has more than one tube a change in the filament circuit may be necessary to make sure that each tube gets enough current.

Let us review the circuits published on pages 18 and 19 of the March 29 issue of RADIO WORLD, with a view of determining their adaptability.

Fig. 1 is of the old type and is to be plugged into the detector socket of the broadcast receiver. It is for DC sets only. When it is plugged in it cuts out of the receiver everything that precedes the detector and utilizes only the audio amplifier. It should be used only in receivers in which the grid leak and condenser method of detection is used.

Fig. 2 is the same circuit as in Fig. 1 except that it is designed for use with receivers in which the detector is a 227 tube.

The single-tube adapters can be used both for code and voice reception. For code it is only necessary to advance the regeneration control until the circuit oscillates; for voice reception it is necessary to prevent oscillation.

## Why Set Wouldn't Work

A man wrote: "When I could not make a circuit work at home I put it in my car and drove over to a friend of mine who is somewhat of an expert in radio. On the way over I had two blow-outs and almost wrecked my car. To add insult to injury a cop handed me a ticket for passing a traffic light. When I finally got to my friend's house I was so disgusted that I did not care whether I got it working at all. To make a long story short, I let him work on it for a while. He checked over the wiring and found it exactly as the hook-up called for. But he could not get a peep out of it. He said that the circuit was not designed right, and that it could not possibly work. Now if you can tell me what the trouble is I'll appreciate it."

From this gossip we glean one bit of information which may have some bearing on the case, and that is the statement that the "somewhat-of-an-expert" could not get a peep out of the set. There was undoubtedly an open somewhere in the wiring, or a short circuit. Perhaps the filament or the plate batteries were not connected, which would come under the classification of an "open." The particular wiring diagram referred to did not show the batteries, so the set could have been wired exactly as described and still not give a peep. But let us assume that the expert attended to the connection of batteries. The defect in the circuit must have been less obvious, and more difficult to find. The answer to an appeal for help in a case of this nature is: Check the circuit over and make SURE that everything is as described. It is not sufficient to believe that it is wired as specified, or to depend on appearances.

As to the rest of the gossip in the letter we are impressed with the importance of starting out with good tires and not to pass a traffic light when a cop is watching while on the way to a friend who is somewhat of an expert in radio with a half-finished receiver. Why not ask the friend the next time to come over with his car and let him take all the risks. He would not be intoxicated with exasperation and could probably get through without trouble. We assume, of course, that he is friend enough not to become exasperated when asked to do a favor.

The example of the gossip type of question cited above is extreme, and a very small percentage of questions are like it, but then there are those that are much more gossipy and more devoid of relevant matter.—A. J. Mason.



# Short-Wave Adapters

and Give Best Assurance of Success

V. O'Rourke

The remaining circuits in the article referred to are of the superheterodyne type and can be used with any broadcast receiver, provided that the voltage supply is suitable.

## Superheterodyne Type Adapters.

In Fig. 3 is a plug-in type circuit designed for battery operation. It is to be plugged into the first socket of the broadcast receiver, provided this is a battery type set. The only precaution necessary is that there be no resistance in the positive leg of the filament circuit of the tube moved from the set to the adapter. It is assumed that there is a 4 ohm, or equivalent resistance in the negative leg. If there should be a resistance in the positive leg it should be removed by short-circuiting. If there is a rheostat in the positive leg it is only necessary to set it on zero. The antenna on the set should be transferred to the antenna post on the adapter and the ground post on the set should be connected to the ground post of the adapter. Only one other connection is necessary, and that is the plate return from the oscillator, which should be connected to a voltage of about 50 volts, on the voltage divider in the set.

Fig. 4 is the same circuit designed for cases in which the first tube of the receiver is a 222. The same precautions apply as in the preceding. In this case it is not necessary to connect the plate return from the oscillator to anything because this has already been provided for.

## One Tube Lost.

Figs. 5 and 6 are the same circuits as those in Figs. 3 and 4, respectively, but are designed for heater type tubes. If the first tube in the receiver is a 227 Fig. 5 should be used and if it is a 224, Fig. 6 should be followed. When using either it is necessary to connect the ground posts of the adapter and the receiver so that there will be a complete circuit for the plate current of the oscillator.

When the circuits in Figs. 3 to 6, inclusive, are used, one tube

## High Sidebands and DX

In some receivers the high audio frequencies are overemphasized. The hissing sounds in such cases are very pronounced, and speech is not pleasant even if it is easy to understand. Moreover, when the high frequencies are stronger than they should be much extraneous noise is brought in to mar reception. A highly selective receiver is not subject to this form of quality, unless the high frequencies have been built up, either intentionally or not, in the audio amplifier. It often happens in transformer coupled circuits that the high frequencies are built up because of a resonant condition between 5,000 and 10,000 cycles, or because of regeneration in this region.

It is practically impossible to receive signals from distant stations without getting an excessive proportion of bass. The receiver must be so selective that it can separate stations operating 10 kc apart without any cross talk. If the carriers of two such stations are modulated with all frequencies up to 10,000 cycles, the sidebands will overlap throughout the spectrum space between the two stations. If they are modulated with frequencies up to 5,000 cycles they will just meet and there will be no overlapping. But there is no carrier which is modulated up to 5,000 cycles and no higher. They are modulated with frequencies up to 10,000 cycles and even higher.

Suppose there are two distant stations operating 10 kc apart and it is desired to receive one of them. It is clear that if the receiver is so broad as to receive all of the modulation on the desired station it will also bring in a good deal of the modulation of the undesired carrier. On the other hand, if it is so selective that it will cut out the undesired station it will also cut out a large part of the desired signals, the higher frequencies suffering first. The signals received clearly must necessarily be boomy.

This is the situation when two stations 10 kc apart are of equal intensity. If one is a local and it is desired to get the distant one, the circuit must be still more selective, and the signals from the distant station will be still more boomy. If the circuit is not selective the distant station cannot be received without loud cross talk from the local station, the signals of which may be much louder than those of the distant station. If the local station is operating 30 or 50 kc from the distant station the situation is about the same as if two distant stations operating 10 kc apart are involved, as the Federal Radio Commission recognizes.

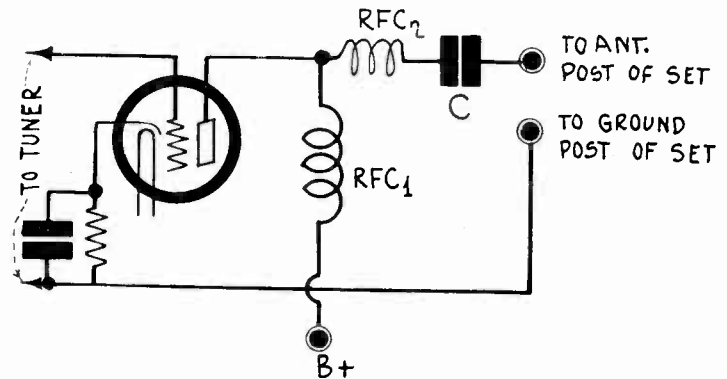

FIG. 13  
THIS ILLUSTRATES ANOTHER COMMON ERROR IN CONNECTING A SUPERHETERODYNE TYPE DETECTOR TO A RECEIVER. THE CHOKE COIL RFC2 CHOKES OUT THE SIGNAL. THE CHOKE SHOULD BE LEFT OUT OR SHORT-CIRCUITED.

and one tuner are sacrificed from the radio frequency amplifier, although one of these tubes are retained as modulator. In many broadcast receivers the sensitivity and selectivity are not high enough to permit this sacrifice. In such cases it is better to select one of the circuits in Figs. 7 to 11, inclusive. These do not entail any sacrifice, for in each case the adapter is a straight addition.

Each one of these circuits contains explicit directions for connecting it to the broadcast receiver. In those circuits in which filament terminals are provided, as in Figs. 7 and 9, either a separate battery or the same storage battery as is used in the broadcast receiver may be used. Also, in all of them with the exception of Fig. 11 the plate voltage supply in the receiver may be used, or a separate source. It is understood that ground is B minus. If the circuit should fail to work when it is first hooked up a check should be made to see that the grounds are connected, or that B minus in the set is connected to the ground post on the adapter.

The circuit in Fig. 11 contains its own filament and plate supply. Hence no special precautions are needed. It is only necessary to make the four connections indicated, and plugging into an outlet.

## Frequent Errors.

Before closing it will not be amiss to point out a few errors that are often made in hooking up adapters of this type to broadcast receivers.

One is shown in Fig. 12 herewith. The modulator tube of the adapter is coupled to the antenna binding post by means of a condenser C. Many have already expressed wonder that this circuit does not work as "described". A tube will not work unless a steady voltage is impressed on the plate. In this case no voltage is applied. There should be a radio frequency choke coil of about 85 millihenry between the plate of the tube and B plus.

Another frequent error illustrated in Fig. 13. The radio frequency choke RFC2 is connected already, but there is one too many coils. The choke RFC2 has no place in the circuit at all. It chokes out the beat frequency signal generated in the modulator and prevents it from reaching the broadcast receiver. Short circuit this coil and the output is right. Note the connections in Figs. 7 to 11, inclusive, in last week's issue. These are correct.

The superheterodyne type adapters can be connected to any broadcast receiver. This does not exclude loop operated sets. If the input is obtained by means of a loop, it may be well to substitute for the loop a small coil of equal inductance. However, it is not necessary.

The adapters shown in Figs. 7 to 11, inclusive, in last week's issue of RADIO WORLD can be mixed. That is to say, a battery operated adapter can be used with an AC operated receiver, and vice versa. The supply for each, however, must be suitable for its particular type.

While it was stated that the superheterodyne plug-in type adapters should be connected in the first socket, this is not essential. It can be plugged into any radio frequency socket. It is, however, desirable to plug in as near the antenna as possible in order to get the greatest sensitivity.

# Wave Forms of Hum

## Bucking Coil Provides Economical Remedy

By John C.

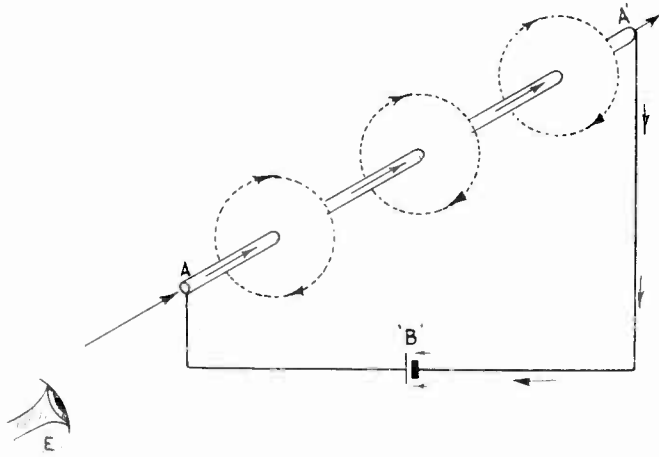

FIG. 1

[The following article is the fourth of a series on dynamic speakers which began in the March 15th issue with the article, "Design of Dynamic Speakers." The pot magnet, voice coil and baffle were discussed. There followed the second article, "A Comparative Test of Dynamic Results," in the March 22d issue, in which acoustic comparisons were made between magnetic and dynamic speakers. In the March 29th issue, "Hum Reduction in Dynamic Speakers" was discussed. Reverse-wound coils and condenser-choke systems were included. This week wave forms in connection with hum reduction is the topic. Follow this series on dynamic speakers from week to week.—EDITOR.]

FIG. 1 illustrates the fundamental relation of the "direction" of the lines of force around a conductor carrying direct-current, to the direction of flow of the current in the conductor. The simplest analogy to this case is that of the right-hand screw, i.e., the forward motion of the screw, away from the observer, corresponding to the current flowing along conductor A—A<sub>1</sub> and, the direction of rotation of the screw while being driven in corresponds to the direction of the circular flux or lines of force around the conductor.

Fig. 1 shows three dotted circles representing lines, whereas in reality there is a very great number, and the "effective" radius from the conductor A—A<sub>1</sub> depends mainly upon the potential difference between the ends of conductor A—A<sub>1</sub>, and the current flow due to this potential difference or voltage.

Fig. 3 illustrates the application of the operating principles of Fig. 2, but it brings out one additional effect in such a way that it could be readily visualized. This same effect could have been demonstrated with sufficiently sensitive apparatus in the case of Fig. 1, but as Fig. 3 shows it more convincingly, I will use this diagram instead.

### Galvanometer Test

If we connect a galvanometer to coil E in Fig. 2 (and we will select a central zero instrument for our present discussion), applying a source of DC voltage to coil E through a telegraph key, so when we close the key we obtain a momentary deflection, after which the galvanometer needle returned to zero, we face a gap in the connection between Fig. 1 and Fig. 3. Here is the connecting link: When the current, starting from zero value, and while on the

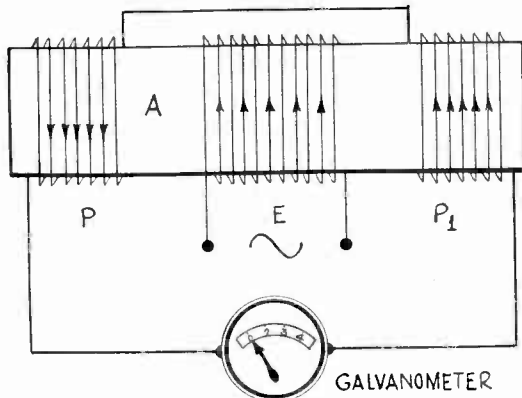

FIG. 2

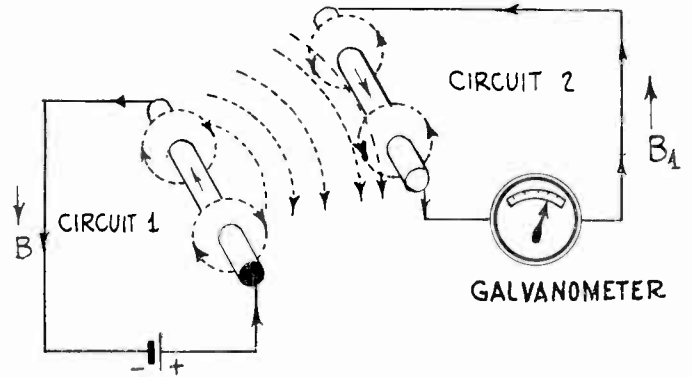

FIG. 3 THE RELATIONSHIP BETWEEN INDUCING AND INDUCED CURRENTS AND FLUXES BETWEEN TWO COUPLED CIRCUITS.

increase, is flowing from A— to A<sub>1</sub> we could slip our galvanometer pickup coil (taken from Fig. 2) right over the conductor of Fig. 1 and observe (as a smaller effect) the very same thing we have just seen demonstrated with Fig. 3. So with results of our observations as they are let's return to Fig. 3. As before stated, on opening the telegraph key we obtain a deflection of the galvanometer needle that is opposite to the original though of similar value, but the point of interest now is that it appeared to be much faster than before.

Now when a current B of electricity starts from zero value to flow through a coil which has an iron core (Fig. 3) the lines of force due to this increasing current start to expand radially outwards from the conductors about which they form, and in doing so cut across neighboring conductors, setting up a current B<sub>1</sub> in these conductors that tends to oppose further increase of current B. These two currents B and B<sub>1</sub> are co-existent and although current B<sub>1</sub> is only effective in opposing current B when B is increasing, B<sub>1</sub> acts to speed up the decreasing value of current B when the key is opened.

### Current Lag

Therefore we find that current B<sub>1</sub> originates slightly later than current B and while B is increasing in value B<sub>1</sub> increases in such a way as to tend to prevent the further increase of B. Then gradually B<sub>1</sub> opposes B less and less as B's value approaches its final maximum. Then as B's value begins to decrease B<sub>1</sub>'s effect begins to help out, resulting in a very rapid decrease in B's value.

Now, this extension of the explanation of the effects encountered in dealing with hum in dynamic speakers furnishes some further ground for explanation.

There are several reasons, as we now know, why the so-called AC hum prevalent in pulsating DC operated dynamic speakers is present.

If an analysis is made of a uniform alternating current it will be found to be a continuously wavy line, which at equal intervals of time (referred to a zero starting point) will have similar values of

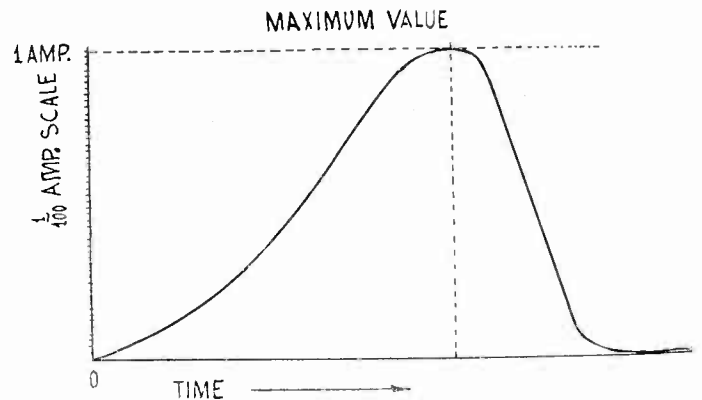

FIG. 4

HOW THE CURRENT FLOW IN 3,000 AMPERE TURN COIL BUILDS UP WITH RESPECT TO TIME. THE MAXIMUM VALUE IS INDICATED BY THE VERTICAL DOTTED LINE.

# Reducers for Dynamics

dy—Some Queer Hum Trouble Analyzed

Williams

positive or negative amplitude depending upon the first point along the wavy line chosen for comparison.

### Use of Half-Wave Rectifier

Now if we use a half-wave rectifier on this alternating current circuit, and assume for descriptive purposes that the rectification is 100 per cent. perfect, we will have the curve of Fig. 5, modified as follows:

Curve  $A_1$  is seen to be similar to curve A in Fig. 5, only the negative half is missing.

I will not take up the operating characteristics of a dynamic pot or field coil on half-wave rectified current because this form, though used in some cases in circuit involving a 281 tube rectifier, is not as widely used as the full-wave type.

In so far as keeping the audible hum within reasonable bounds, the half-wave rectifier certainly can be used, but due to the fact that larger capacity and higher rating condensers and chokes are required to handle the surge voltages incidental to such operation, and other economic reasons, the popularity of this type is not great for home use.

The next item of interest is the full-wave rectifier, and again we

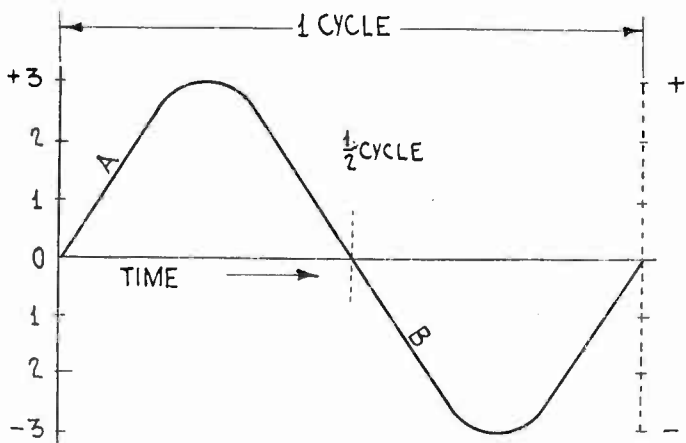

FIG. 5

are going to assume 100 per cent. operating efficiency. A full-wave curve is shown in Fig. 8.

### Reproduction as Two Positive Halves

Now here we have a condition which shows we can take the curve of Fig. 5 and reproduce the lower half wave, or negative half wave or alternation, as a second half-wave above the line O. Hence the name half-wave. In this circuit the *positive* loop of the alternating current of Fig. 5 appears in Fig. 8, "as is," and the previous *negative* loop appears now as a positive loop, so we have the case of the positive and negative parts of an alternating current cycle reproduced as two equal positive parts and producing very much more nearly even pulsating DC than the half-wave circuit did.

Now it is the shape of the pulsating DC curve as modified from the ideal form of that of Fig. 8 by the various forms of hum reduction circuits as described in last week's issue that we wish to study next.

Let us make a setup of a circuit similar to that of Fig. 7. Let this magnetizing coil consist of 3,000 ampere turns, and let the final exciting current be one ampere, and also assume a suitable source of emf to provide exactly that final current, and a central zero ammeter with a scale of 1—0—1 by hundredths of an ampere, and a telegraph key to complete the circuit when we are ready.

We close the key and watch the ammeter needle. It gives a slight jump and increases slowly as it passes through the mid-point of its deflection, slowing down slightly as it reaches its final maximum value.

### Use of a Shunt

Then if we arrange to shunt the exciting source with another similar meter, as we open the key we can observe the *decrease* of the current in our coil, and it will be found to drop to zero suddenly. A rough graph of this condition is shown in Fig. 4.

What we have observed is that in circuits containing a relatively large amount of inductance there exists (when the exciting current is increasing) a counter-current that comes into action a few hundredths of a second *later* than the original exciting current, and the later current is said to lag behind the exciting current. The time of this lag in fractional parts of a second is greater as the inductance of the coil is greater, or less as the inductance is less.

Now if we can visualize what we have learned it is apparent

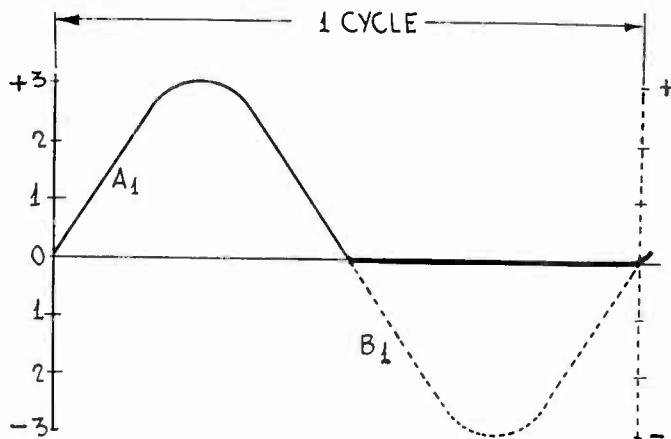

FIG. 6

A SINGLE CYCLE OF ALTERNATING CURRENT OR VOLTAGE, SHOWING HOW SUCCESSIVE VALUES ARE ATTAINED ON A 3-VOLT (MAXIMUM) AC CIRCUIT.

that as the magnitude of the inductance of our coil has the property of limiting the time rate of increase of DC the same condition will apply to pulsating DC also.

Let us now substitute a source of full-wave rectified alternating current for the DC source.

Here the conditions, while being somewhat similar, yield results that are different.

### Explanation of Interrupted Line

The "interrupted line" curve of Fig. 8 shows how the general form of the full-line curve would be altered by connecting the previously described coil to a full-wave pulsating DC source, of which the full-line curve shown in Fig. 8 is an example. Now, in a dynamic speaker pot coil similar to Fig. 7 no device is employed to reduce the hum save the coil *K*, and its effectiveness depends upon the inductance of the associated magnetizing coil shown.

Fig. 9 shows a "curve" that illustrates the effect of the use of a combination of coils similar to those of Fig. 10, and its effect is shown for comparison with that of Fig. 4, which is for the case of Fig. 7.

As before stated, this curve is somewhat similar, and inspection shows that the rising part of curve E is modified by the effect of the reversed current coil's reaction. Curve E—e is the effective emf or resultant that magnetizes the core and produces the first *half cycle* of the voice coil hum. Curve E, descending, is what happens when the reverse current coil is open-circuited, when the applied emf falls. Curve E+e is what happens when the applied emf falls when the reverse current coil is a closed circuit.

### Modified by Stabilization

It will be seen that two effects, similar to what we have just discussed, occur here, but they are modified by the stabilizing action of the reverse coil winding, which has the effect of a stabilizing agent, analogous to that of a storage battery, a compressed spring, or a condenser, or any other devices that receive surplus energy, store it, and then return the energy in such a manner that useful work may be obtained or done by such stored energy. As in the cases above, this reverse-current coil stores a part of the energy impressed upon it during the first half of the hum cycle and returns

(Continued on next page)

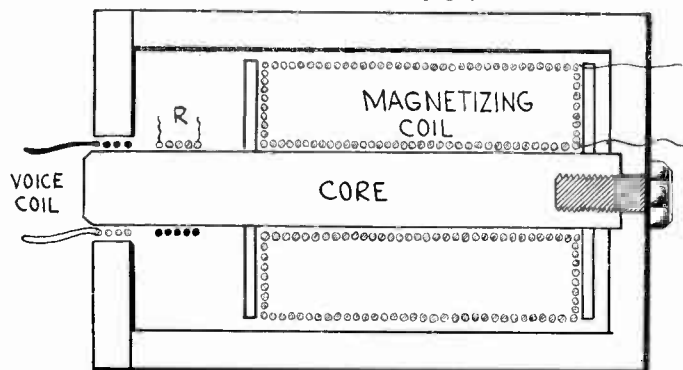

FIG. 7

# Magnitude and For

## Satisfactory Subduction is Readily

(Continued from preceding page)

what it stored during the second half in the form of reversed current of an effect to prevent the sudden collapse of E on its downward travel and thus prevent induction of a large half-cycle hum when the applied emf returns to zero value.

The above effects are all due to inductance, which is the electrical equivalent of inertia in a mechanical system. The various effects brought about by combining coils of high inductance with those of low inductance, or those coils that utilize reversed turns, are comparable to mechanical systems that go by the name of shock absorbers.

### Economical Solution

The interesting feature about a successful reverse-current system of reducing hum in AC operated dynamic speakers is that it is so very much more economical than using a unilateral condenser, and

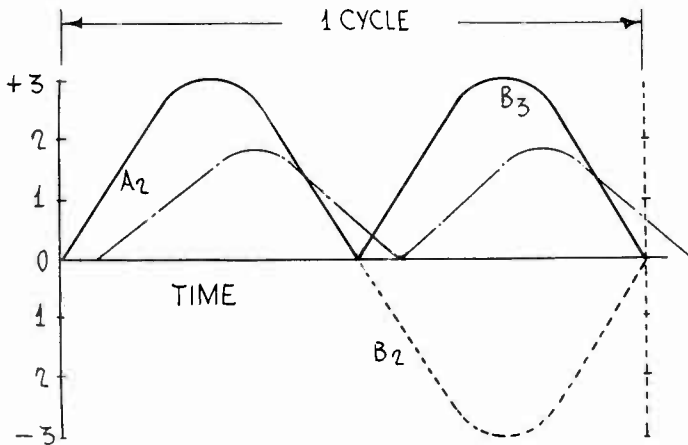

FIG. 8 THE EFFECT OF PASSING CURRENT OF FIG. 3 THROUGH AN IDEAL RECTIFIER. FULL LINE CURVE SHOWS FULL-WAVE RECTIFIED CURRENT. THE INTERRUPTED LINE CURVE IS DISCUSSED IN THE TEXT.

also the coil requires much less room and is an integral part of the design of the speaker.

Now the curve of Fig. 9 is of one second duration and this means that we had to be agile and try to plot all the points of interest as the current rose and fell, and the only way that we could present it to you as a still picture was to divide the time taken by a pulse to rise to its maximum, and fall again to zero, into 60 equal parts. The elapsed time required in this case becomes one second. By reference to Fig. 9 it will be seen that the greatest difference between E and E-e occurs between 4 and 7 volts, and at about 12/10 of a second from the time the exciting emf is applied.

As the current increases, the difference between E and E-e becomes less, until somewhere near the maximum value they become merged and E-e is no longer a measurable quantity.

### Different on the Decrease

On the decrease of E, however, it's a very different story. The value of E is plainly seen sustained by the effect of the reverse current coil, which produces E+e now, and at a time rate of decrease of voltage nearly similar to that part of the ascending curve that lies between 4 and 9 volts, so that although the difference between E and E+e is greater than E and E-e, their respective average maximas occur at about the same lapse of time from their respective starting places, namely, the center of the two vertical lines that drop from 4 and 7 volts on the ascending curve is the same distance from the origin as the center of the two vertical lines that drop from 7 volts and 4 volts from the maximum value vertical.

Now other similar vertical lines may be dropped to the 1/10 second scale on the zero axis and these will afford a ready means of obtaining a quick comparison of the way the various current values vary with successive equal lapses of time, referred to as zero or starting value.

Another way of reading a graph of this kind is to place a card with its edge parallel to the voltage axis and, keeping this edge parallel, draw the card slowly across the graph. The result will be not unlike an animated movie.

### Wattage Considerations

This curve does not show the distribution of energy very well on the basis of AC watts per unit of time, but if it was desired

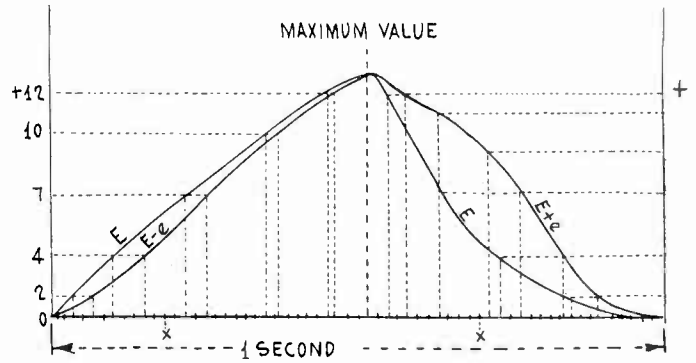

FIG. 9 A STATIC CURVE OF THE EFFECT OF THE REVERSED CURRENT COIL OF FIG. 4 WITH RESPECT TO TIME—AND ALSO SHOWS HOW THE VOLTAGE COMPONENTS ARE DISTRIBUTED.

to obtain these data from the curve given (and only an approximate curve could be shown), the successive points could be plotted with reasonable accuracy by the use of a good DC voltmeter on the exciting circuit.

The method to be followed here would be to have a variable series resistance in the exciting circuit and with the DC ammeter and voltmeter ready, close the key and adjust the resistance so that the voltage drop across the 3,000 ampere turn coil was 2 volts. Then read the current and multiply it by the voltage drop. Then repeat with the DC volts at 3 volts, then 4 volts, and so forth, up to 12 volts. This will result in a uniformly increasing and decreasing curve, and if this line of values represented by suitable dots placed within the two curves, shown at the approximate center, is established, a wattage curve that is roughly correct will be obtained.

But we have not shown a curve of the relative change in the values of a rectified wave by a reversed current coil and so this appears now.

### Hum Values

Fig. 11 shows a current of one ampere at X hum volts of full-wave pulsating DC. The — hum volts are generated by a voice coil placed in the air gap of the dynamic pot. Curve 1 shows what 1 ampere looks like with its fill of harmonic values that tend to boost its value apparently. Curve 2 shows what it is like after the reversed current coil is operated. Incidentally, we must not forget that a condenser of the unilateral type, in the case of low voltages, or a regular condenser and external choke coil in the case of higher voltages, would tend to produce a condition similar to that of the curve 2 of Fig. 11.

So Fig. 11 shows the final result of reducing audible hum to inaudible values—and any combination of magnetizing coils and reversed windings will begin to approximate the desired result obtainable with proper combination of magnetizing coil inductance and ampere turns, on the one hand, and ample space for opposing voltage coils on the other.

Of course there is a compromise here, but given enough iron of good quality and an efficient rectifier, whether it be the dry plate or tube type, the designing of a good humless pulsating field for a dynamic speaker is not impossible.

For the case of dynamic speaker pots that contain high voltage windings, the problem of reducing audible hum is usually made very much simpler by the relatively high inductance per unit of copper volume of the higher resistance coils which usually have a minimum of 20,000 turns or thereabouts. These coils are usually component

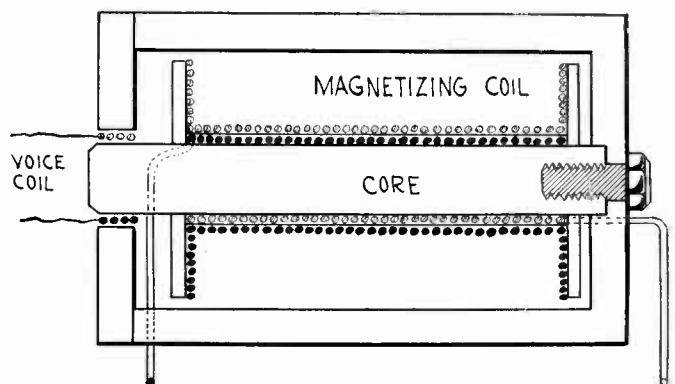

FIG. 10

# m of Ripple Voltages

## Attainable in Dynamic Speakers

parts of a filter system in the broadcast receiver and serve as "chokes." The real idea is to kill two birds with one stone utilizing the normal inductance of the coil as a means of smoothing out the B supply ripple and incidentally providing a source of pulsating DC power to energize the speaker pot.

The hum problems involved here are not always basically the same as with the low-voltage rectified DC cases.

Of interest though in this connection are the many other ways in which hum troubles arise, and in most cases the speaker, being the most vulnerable point of attack, is usually blamed first. One of the underlying causes of excessive hum that sometimes develops several months after the set is bought, is due to a high voltage condenser beginning to leak. Another is changes in the operating characteristics of tubes—notably the detector which will set up a source of hum if it gets into the ionizing state—a condition which is due to the presence of gases within the tube, that have escaped from the metallic structure of the tube elements.

### Hum From Unexpected Sources

If you have a combination of a battery-operated set and an AC operated speaker, and excessive hum develops, it is probably due

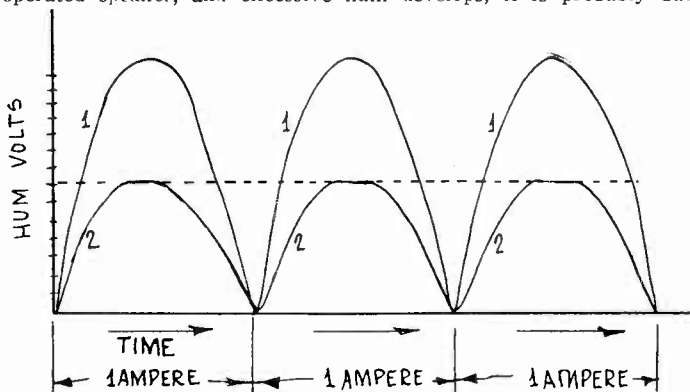

FIG. 11

THE REDUCTION OF HUM VOLTAGE. CURVE NO. 1 IS HUM VOLTAGE WITHOUT OPPOSING EFFECT OF REVERSE CURRENT COIL. CURVE NO. 2 SHOWS HOW THE HUM VOLTAGE IS REDUCED BY THE ACTION OF THIS COIL.

to the rectifier beginning to pass too much AC component. If you have a battery-operated set, and are using a B eliminator, and the speaker is dry rectifier-operated, and excessive hum develops, then look for hum in the receiving set output, first by advancing set controls to full volume, then detuning the set and connecting up ear phones in place of your speaker.

If you can hear any hum in them the trouble is very likely in the B eliminator. Otherwise shunt a 1,500 mfd unilateral condenser around the DC side of the dry rectifier, being careful to observe polarity, which can be observed easily by a low-range voltmeter or polarity indicator. If neither of these is available, two leads attached to the rectifier DC output may be thrust into a clean, freshly peeled potato. The negative lead will discolor the potato faster. The condenser is to be connected accordingly.

Another removable cause of hum is the segregation of all the

leads in the home-constructed receiver that are near strong AC fields—this applies especially to grid and screen-grid leads and long parallel runs.

### Voltmeter Tests

In dry rectifier-operated speakers it is a good plan to check up once in a while on the value of the pulsating component, and subtract from it the DC applied voltage as measured at the rectifier terminals by a DC voltmeter. The procedure is this: With the speaker pot energized connect an AC voltmeter to the point where the pot coil leads are attached, and take the reading. Then connect the DC voltmeter to the same two points and take the reading. Now the AC voltmeter reading minus the DC voltmeter reading should not be more than about 40% of the AC voltmeter reading, else the hum will be excessive. This is a case which can only be cured by a unilateral condenser.

### Condenser Effect

The effect of this condenser is to increase the value of the DC voltage component at the expense of the pulsating component, actually increasing the applied DC wattage. Of course the hum is substantially reduced. The useful life of a unilateral condenser is considerable, as long as the peak (or pulsating) voltage does not exceed the manufacturer's rating, usually printed on the label. For instance, some commercial condensers are rated to operate on circuits not exceeding 12 volts maximum, and such a rating, while stating the allowable maximum, should not be taken literally. Experience shows that 8 to 10 volts pulsating component is about the safe continuous operating maximum for condensers of 12 volt rating, and therefore the condenser may be used for a very long period on a 6-volt DC circuit.

## Definite Diagram for Pocket Set

Herewith is a diagram of "A Pocket Size Set." The article was published last week in the March 29th issue, page 6, but the diagram published then made it appear that screen grid tubes were optional. The tubes to use are 199 throughout, and this fact is established on the definitive diagram herewith.

The circuit is a good performer and is very conservative in battery drain, so dry cells may be used throughout. Of course, a B battery consists of dry cells, too.

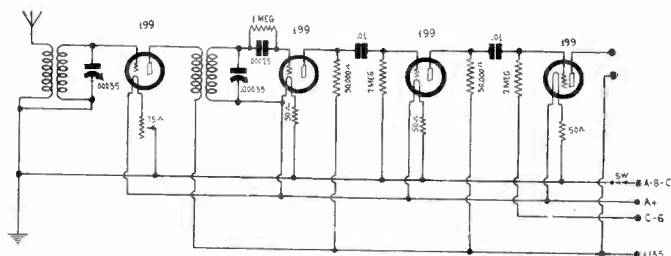

DIAGRAM OF A 4-TUBE POCKET SIZE, SHOWING THAT 199 TUBES ARE TO BE USED THROUGHOUT.

## Find-All Four Popular With Distance Fans

Those who are in doubt as to whether a four-tube receiver can give satisfactory volume and distance reception can make the test with a Screen Grid Find-All Four.

This circuit utilizes the latent possibilities of the 222 screen grid tube and as a result exceptional distance records have been reported. A number of verifications of reception from Europe, Japan and Australia is claimed.

The Find-All Four operates on the regular broadcast band. It is not a short wave set. It is battery-operated. This receiver will work well with A and B eliminators, thus giving the convenience of batteryless operation. Although this set is compact, it can be used with the ordinary speaker or with the most modern dynamic reproducer.

The four tubes required are a 222 tube, two 201A and a 171A. In addition to the A battery, three 45-volt B batteries are necessary and two small C batteries.

In design, this receiver follows modern practice. It utilizes the latest type aluminum chassis, with all parts except the variable tuning condensers, below the deck. All wiring is concealed

and the tube sockets are mounted from below, so that they are flush with the chassis deck. The RF coils are specially designed and specially wound for this circuit and the use of these coils adds considerably to the distance range of the set. Two stages of audio frequency are used, necessitating the utilization of two high-grade audio frequency transformers. The use of such transformers is more than justified by the marvelously clear tone quality of the set. A genuine bakelite panel adds to the attractiveness of the Find-All receiver. Two vernier dials are used, as it has been found that two dial control gives sharper tuning for greater distance.

A Find-All owner of Bend, Oregon, has written to the manufacturer as follows:

"For volume and selectivity, I have never seen or heard any set that will equal it and, as for tone, it simply cannot be beat. There have been several people watching me build this set and they are all talking of getting one. The compactness is what seems to strike everyone. They can't feature a set so small doing what it does."

# Bewildering Simplicity of Tune RF Needed Ahead of Lofti

By J. E.

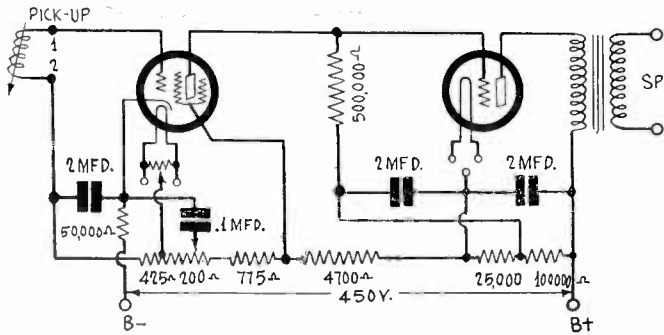

FIG. 1

THIS SHOWS HOW A PHONOGRAPH PICK-UP UNIT SHOULD BE CONNECTED TO A LOFTIN-WHITE AMPLIFIER.

MANY radio fans who have built Loftin-White amplifiers are bewildered. They have built them "just as specified," but what are they to do with them? Are they to use them for radio reception or only for amplifying the signals from a phonograph pick-up unit? Nearly all the Loftin-White amplifiers published show two tubes with the input terminals to the first left open. What to do with these terminals is usually left to the builder to determine, and it is just there where the bewilderment enters.

The ballyhoo about these amplifiers emphasizes their remarkable simplicity, high amplification, inexpensiveness, superior tone quality, and their freedom from hum. The fact that most of this ballyhoo is true does not in the least help the fans to use the amplifiers.

Some fans have been led to believe that if a single radio frequency tuner is connected to the input terminals of the amplifier a superior sort of radio receiver will result, one that is exceptionally selective and sensitive. Those who have taken this part of the ballyhoo have discovered that they have something which is not much better than the old crystal set of 1922. And they want to know what is wrong with their Loftin-White amplifier.

Chances are that there is nothing wrong with the amplifier. They have just made the mistake of believing that a single tuner is any more selective in 1930 than it was in 1922, that a new name for an amplifier is a substitute for radio frequency amplification.

### Provide RF Amplification.

The Loftin-White amplifier will not deliver any signals to the loudspeaker unless it be given something to work on. If the amplifier is to be used for amplifying phonograph pick-up signals it will be sufficient to hook the terminals of the pick-up unit to the input terminals of the amplifier, but if it is to be used for radio reception it is necessary to provide radio frequency amplification as well as plenty of tuners. Just how many stages of radio frequency amplification are necessary depends on the sensitivity that is desired, and just how many tuned circuits are needed depends on the sensitivity as well as on the location of the receiver with respect to strong stations.

While non-reactive amplifiers with suitable radio frequency amplifiers and tuners have been published many times in the RADIO WORLD, it will not be amiss to give additional circuits for a large number of readers have written in for information on the subject.

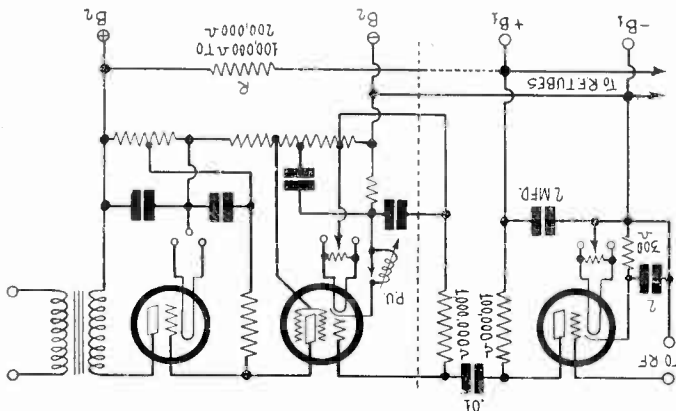

FIG. 2

WHEN A LOFTIN-WHITE AMPLIFIER IS CONNECTED TO AN EXISTING RADIO FREQUENCY AMPLIFIER AND TUNER IT MAY BE COUPLED BY MEANS OF AN ORDINARY RESISTANCE COUPLER AS HERE SHOWN.

The questions usually demand to know what kind of tuner is needed and how it should be connected to the non-reactive amplifier. Other questions are associated with complaints to the effect that no results are obtained, or very unsatisfactory results, when a single tuner is preceding the non-reactive amplifier. No one who has read the preceding paragraphs about the fallacy of expecting good results when there is no amplification at radio frequency and only one tuner should register any complaints.

### Phonograph Pick-Up Connection

The connection of a phonograph pick-up unit to a Loftin-White amplifier is shown in Fig. 1. The usual input terminals of the non-reactive amplifier are numbered (1) and (2) and the pick-up unit is connected across these. That is all there is to the connection.

The various values of condensers and resistors are given in the circuit for those who desire to hook up one of the amplifiers. The total voltage that should be applied across the B terminals is 450 volts. Many fans have asked concerning the necessity of using this voltage. The various resistors have been determined on the basis of this voltage and, therefore, it should be used. If it deviates a little up or down no great change takes place in the operation of the receiver. It is important to realize, however, that much lower voltages will not give satisfactory operation. There is always a temptation to use a lower voltage, say 250 volts, and many questions demand to know what the changes in the circuit should be to make this voltage suitable. The answer to these questions should be: Raise the voltage to 450 volts.

When a radio frequency amplifier is to precede the non-reactive audio amplifier it might be coupled as shown in Fig. 2. The first tube shown in this circuit is the detector, and this is followed by a regular resistance coupler. The dotted line shows the separation between the non-reactive amplifier and the detector. The design of the audio amplifier is exactly the same as that of the circuit in Fig. 1.

Note that the B supply for the detector tube is taken from the supply for the non-reactive circuit. The plate return from the detector is connected to the high voltage tap through a resistor of 100,000 or 200,000 ohms. The supply for the radio frequency tubes ahead of the detector can be taken from the same line, but the resistor should then be considerably smaller, depending on the number of tubes and the voltage desired on these plates.

If it is desired to arrange the circuit in Fig. 2 so that a phonograph pick-up unit may be connected with a minimum of changes it is possible to put the unit in series with the cathode as indicated by PU. A switch may be provided so that the unit may be short circuited when radio is to be received. It is also possible to remove the one megohm grid leak and substituting the pick-up unit. Of course, when the pick-up unit is put into operation the radio frequency circuit should be killed.

### Use Separate B Supply

While it is quite feasible to use the same B supply for both the non-reactive amplifier and the radio frequency circuit, it is preferable to use separate supplies. This imposes no additional hardships because a low voltage supply suitable for the radio frequency amplifier and detector is available in most instances and a higher voltage unit must be provided for the non-reactive amplifier in any event. When two units are used the B minus of both should be connected together. The use of two separate supplies is preferable because the varying current demands of the radio frequency amplifier will have no effect on the voltages applied to the non-reactive circuit.

It is also feasible to connect the radio frequency amplifier so that a tuner is between the last RF amplifier and the first tube of the non-reactive circuit. When this is done the first audio tube becomes not only the first audio amplifier but also the detector. Fig. 3 shows how the connections should be made. Two separate B supplies, B1 and B2, are suggested. Note that B1 minus and B2 minus are connected together. The terminal P goes to the plate of the last RF amplifier tube and B1 plus not only is connected to the return of this plate but also to the returns of all the other RF tubes in the circuit. This is standard and need not be shown in detail. But the builder should realize that several stages of amplification and several tuners are needed if the receiver is to be sensitive and selective. The non-reactive amplifier assures first rate quality but not sensitivity and selectivity.

### Factors Affecting Choice

When considering the question of choice of RF amplifier the fact that the non-reactive amplifier is a two-stage audio frequency amplifier and not a license for casting aside common sense should be kept in mind. If the non-reactive amplifier is a little more

# Non-Reactive Amplifiers

## Loftin-White Circuits for Good Results

Anderson

sensitive than an ordinary two-stage amplifier, that is just so much gain.

If the radio frequency amplifier is of the neutrodyne type with three independently tuned circuits ample sensitivity and selectivity should result from two RF tubes and three tuners. Likewise, if the RF amplifiers contain regeneration and the tuning condensers are independently controllable, two tubes and two tuners should be sufficient. On the other hand, if the tuning condensers are ganged it may be necessary to use four or more RF tubes and tuners. Just how many are required depends on the degree of shielding, on the accuracy with which the tuned circuits track, and on the kind of tubes used. Accessible trimmer condensers on ganged condensers often make it unnecessary to use an extra stage of amplification and an extra tuner.

If a radio frequency amplifier of any kind is available and it is desired to use this in conjunction with a non-reactive amplifier it is well to use all of it, including the detector. If the amplifier is sensitive and selective enough when an ordinary audio amplifier is used it will be so when a non-reactive circuit is employed. A simple way of combining the two is illustrated in Fig. 2. If separate B voltage supplies are to be used in this connection it is only necessary to remove the high resistance R and to connect the low voltage B supply to the terminals marked "To RF tubes," as marked by the terminals B1 minus and B1 plus. Lower voltages may be required for the screens of the tubes in the RF amplifier, but they will be provided for in the low voltage B supply.

Fig. 4 shows a general arrangement for connecting a non-reactive amplifier to an existing radio frequency tuner and amplifier, in which the detector of the RF circuit is used in the combined circuit. Separate voltage supplies are supposed to be used.

### DC Non-Reactive Circuits

From the first appearance of non-reactive circuits of the Loftin-White type letters have been received from fans everywhere asking for similar circuits for direct current tubes. These writers cannot receive much encouragement because DC tubes and Loftin-White amplifiers do not mix. This type of coupling was made practical by the heater type tube.

While it is theoretically possible to use the same circuits with DC tubes it requires a separate filament battery for each tube. Even when this condition is complied with the problem is not solved because there is considerable leakage from one battery to the other, especially when storage batteries are used, and this leakage upsets the voltages. There are other non-reactive circuits available for DC tubes, circuits which are capable of just as good quality as the Loftin-White circuits. It is true that they are somewhat more complex but that is one of the penalties for living in a DC district, or in districts where no electricity other than that furnished by batteries is available.

Non-reactive circuits for battery operation have been published in RADIO WORLD many times, and the reader is particularly referred to Feb. 1 issue. There the Arnold circuits are given, one of which was for a time called Loftin-White. There also is given the Hartley regenerative, non-reactive amplifier, the Morgan circuit, and the Johnston. Those who are forced to use batteries and want to sample the quality obtainable with non-reactive amplifiers are especially referred to the Morgan amplifier. No better amplifier has ever been designed as far as quality is concerned. The only disadvantage of the circuit is that high voltage batteries are needed, batteries to take the place of the higher voltage supply in the Loftin-White amplifier.

### The Johnston Circuit

The Johnston circuit is also capable of first rate quality but it is only applicable where a high voltage of high current rating is available. For example, it is suitable for use on DC power lines of voltages around 250 volts. The high current rating is necessary because the filaments are heated from the same source. There is no place in the United States or Canada where a high DC voltage is available so there is little need for the Johnston type of circuit on this continent.

The Morgan amplifier, however, can be used anywhere since it is battery operated. The filament battery, which is used for all the tubes, may be a regular storage battery and the grid and plate batteries may be either dry cell or storage batteries. Comparatively few have built this circuit but those who have are enthusiastic about its quality.

Every one who builds a non-reactive amplifier of the Loftin-White type should remember that the two tubes should be heated with separate filament windings and that the insulation between these winding should be high enough to withstand voltages higher than

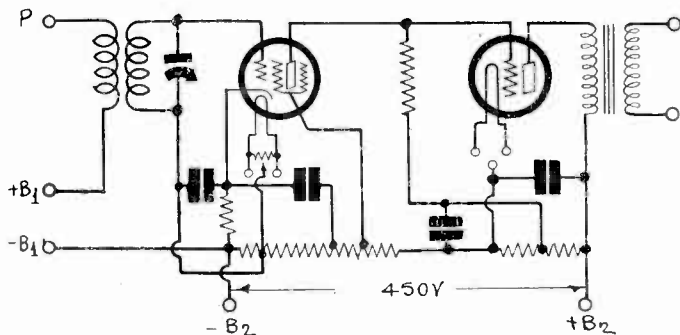

FIG. 3

THE FIRST TUBE IN THE NON-REACTIVE AMPLIFIER MAY BE USED AS DETECTOR, IN WHICH CASE THIS SHOWS THE CONNECTIONS.

the applied voltage on the first tube. This applied voltage is approximately the voltage difference between the cathode of the first and the filament of the second. If the two tubes were put on the same winding this voltage would exist between the cathode and the heater of the first tube, which would undoubtedly ruin the tube.

In case there is a stopping condenser between the plate of one tube and the grid of another, as in Fig. 2, the two tubes separated by this condenser may be put on the same filament winding. Likewise when two tubes are coupled with a transformer they may be put on the same winding. It is only when they are coupled directly as in the Loftin-White system that they must be on separate windings.

In building a Loftin-White amplifier it is absolutely essential that the total applied voltage be high enough to provide 250 for the plate of the power tube and as high as practical for the screen grid tube. One of the reasons for connecting the plate return lead to a point higher up than the filament of the power tube is to increase the voltage on the plate of the screen grid tube.

The reason for using a high voltage on the plate circuit of the screen grid tube ahead of the 245 is that there must be ample latitude for the signal voltage to swing enough to load up the 245 tube. The double amplitude required for the 245, with 250 on the plate and 50 on the grid, is 100 volts. When the drop in the coupling resistor is 100 volts there must be something left for the plate. If we have a voltage of 200 in the plate circuit the minimum drop in the tube itself would be 106 volts, which is the effective voltage on the plate. Of course, it is possible to operate the circuit with a lower minimum voltage provided that the screen grid voltage is made lower. In every Loftin-White circuit there is a provision for adjusting the screen grid voltage to match the voltage available in the plate circuit, or at least there should be.

Many non-reactive amplifiers have been published purporting to be Loftin-White, but not all of them should be blamed on these engineers. The circuits they have worked out are characterized by a hum-bucking condenser and by a high resistance in the cathode lead of the screen grid tube, higher than that necessary to give the proper bias to the control grid. Fig. 1 shows a typical circuit of this type. Both of these exclusive features are highly important. The hum-bucking condenser is effective in eliminating the hum and the cathode lead resistance in stabilizing the circuit. With these features the circuit works admirably.

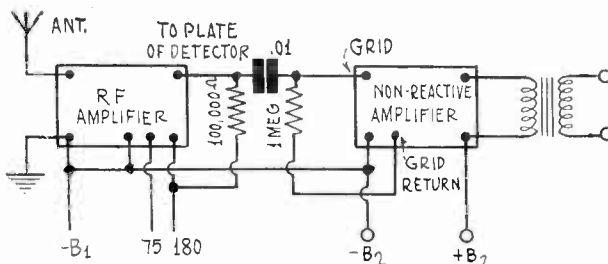

FIG. 4

A GENERAL LAYOUT FOR CONNECTING AN EXISTING RADIO FREQUENCY AMPLIFIER TO A LOFTIN-WHITE AUDIO AMPLIFIER. SEPARATE B SUPPLIES ARE USED FOR THE TWO PARTS OF THE CIRCUIT.

# Resolved, That Dynamic Sp

## AFFIRMATIVE

*Elwood Marrison*

**T**HE superior merits of the dynamic speaker are so well known and so well established by every test that it seems futile to discuss the matter. Yet there are those who still cling to the hopeless position that the magnetic speaker is superior in respect to tone, volume, economy of operation, and other practical properties. For this reason I shall discuss some of the properties of the dynamic which won for it the rapid and overwhelming endorsement of engineers and laymen alike.

Certainly if the dynamic speaker were not superior to the magnetic radio engineers everywhere would not have specified such speakers in manufactured receivers when magnetic speakers can be made for a much lower figure. These engineers have put the various kinds of speakers through every imaginable test with a view of finding that speaker which will give the best service at the lowest cost consistent with high quality. If the dynamic had not won in the contest by a wide margin, not one manufacturer would have put such speakers in his receivers. The difference in cost would have decided the issue definitely. The fact is that in the search for quality the engineers of all manufacturers decided on dynamic speakers.

If we insist on the superiority of magnetic speakers, or even on the equality, we charge both the engineers and the manufacturers with stupidity, a charge which cannot be made by any rational man. Not only do we accuse them of stupidity but also the broadcast listeners, which almost without exception, have selected the dynamic speaker when they had a chance to compare the two types.

### Expense Not Important.

It is admitted that the dynamic speaker costs a little more than the magnetic, both to buy in the first instance and to maintain. But cost is of no importance when the question is realistic tone quality versus the tinny sounds that cursed the radio industry when the magnetic speaker was in vogue.

Moreover, the difference is not so great that it should affect the choice of the ultimate consumer no matter how lean his purse may be. Since dynamic speakers were made in large quantities the cost of a good speaker of this type has been considerably lower than the cost of a magnetic speaker of tolerable quality. In the few instances when magnetic speakers have been selected in preference to dynamics the choice has usually been decided by considerations different from cost or operating expense. Usually the deciding factor has been prejudice engendered by earlier associations with a certain type of distorted quality. Sometimes the choice of a magnetic speaker only indicates that the person making the choice is ultra-conservative—mentally imprisoned by the "good old days." In no case, since the advent of the dynamic speaker has a deliberate choice of a magnetic speaker been based on an appreciation of realistic quality or on the impartial results of laboratory measurements.

The cost of maintenance of a dynamic speaker, even one of the most powerful, is so small that no one would notice it on the monthly electric bill. A dime at most, and is not a dime a month a low price for the very highest quality? Any rational individual who was convinced that there was the slightest quality advantage in the dynamic would gladly pay the extra cost.

It may be argued that rectifier units need frequent replacement and that the cost of new units will amount to a large sum in the course of a year. Just what this cost will be is not known yet, for there has not yet been a general break-down of the rectifier units in the first dynamic speakers sold. Since this is several years and the speakers are still working as well as when they were new, there need be no hesitancy on this point. Moreover, this could not possibly be a source of expense of any magnitude because the speakers as a whole do not cost a great deal, much less a minor part of the speaker assembly.

We can dismiss the question of cost and expense just as most of the radio listeners have already done.

### Rationality of Majority.

It is unreasonable to assume that 99 per cent. of the broadcast listeners are deceived by the speaker manufacturer's publicity in favor of dynamics. We cannot wholly discount the deliberate choice of millions of people who have picked dynamics and take cognizance only of the few who now prefer magnetics. Most people can judge quality for themselves and they know what is the most nearly realistic. They pick out deficiencies just as quickly as the sound engineers, although they may not know the exact causes.

It was not until the dynamic speaker was made available that broadcast listeners were given an opportunity to listen to the

wonderful quality that may be obtained from modern high power amplifiers, such as those that incorporate 245's or 250's in push-pull. Not that the amplifiers did not turn out as good quality before as they did afterward, but the magnetic speakers were not capable of handling the volume on the low notes. The speakers rattled as soon as the volume was turned up, and this rattling not only spoiled the low note reproduction but the entire output. The wide possible swing of the armature of the dynamic permitted large amplitudes, as required by high power, low note reproduction, and that without ever touching the fixtures in the speaker assembly. Thus the signals were reproduced strong and clear and with true amplitude relationship among the notes of different frequency.

It was not until these amplifiers and the dynamic speakers were combined that the orchestra was lifted from the concert hall and transported to the home, that the great organs were erected in the living room, that the voices of the great singers were recreated at the fireside. Previously the orchestras, the different instruments and the great voices were only misrepresented in the home.

While good quality can be produced with a specially constructed magnetic unit coupled to a long exponential horn it is not practical to use such combinations in the home, or even in a small hall. The exponential horn required would be so large that all the furniture would have to be moved out of the home and the fans would have to find a listening post somewhere inside the enormous horn. This would scarcely be comfortable and they would not get the benefit of the good quality which the combination would produce.

Moreover, the cost of a specially constructed magnetic unit and the exponential horn would be greater than half a dozen of the finest dynamic speakers ever produced. The rent for the space occupied by the horn alone in many instances would amount to more than the upkeep cost of the entire radio receiver equipped with a good dynamic speaker.

### Hum Objections.

There may be an objection to dynamic speakers on the ground that they often hum more than magnetics. When they do hum, of course, this must be counted against them. But why should a good dynamic hum? It does not do it. Sure, it is possible to get dynamic speakers that hum but in comparing speakers we must not compare the cheapest of one class against the best of another. Neither should we attribute hum to the speaker that originates in the amplifier. It is a fact that the most serious hum in any case arises in the radio frequency or audio frequency amplifier, and this hum will be brought out both by the magnetic and the dynamic speaker. It is a signal as far as the speaker is concerned, and the more this hum is brought out the better is the speaker for it indicates high efficiency on the low notes.

So if the dynamic hums a little more than the magnetic it is a point in its favor, a strong point indeed. The remedy is not to tinker with the speaker, or to substitute an inferior speaker, but to remove the source of the hum in the amplifier or in the B supply. In nearly all cases the trouble can be removed, even to suit the most efficient dynamic, by introducing more filtering in the B supply unit, or by selecting a B supply that is adequate for the receiver in question.

The hum produced by the average dynamic speaker is usually so low that it cannot be heard without putting the ear next to the sounding cone. It is so weak that it does not interfere with the signals a few feet from the speaker. What possible objection can there be to a hum that cannot be heard unless the ear is put up against the cone? Surely that is never the normal position of a broadcast listener.

Moreover, not all dynamic speakers hum by even that amount. Those that hum just a little bit, a negligible bit, are those that have in-built rectifiers of the low voltage type. There are other speakers which operate on high voltage rectified current, often taken from the B supply in the receiver or from a special rectifier-filter. These do not hum, as a rule. The fact that the former type is more popular shows that their disadvantages over the hum-less variety is discounted by the majority of listeners, and therefore the hum cannot be objectionable, if noticeable.

We are forced accordingly to admit that the dynamic speaker is superior to the magnetic because from every viewpoint the advantages of the dynamic outweigh those of the magnetic, and the disadvantages are comparatively unimportant. The factors which weigh strongly in favor of the dynamic are: that nearly all radio and sound engineers select these speakers; that laboratory measurements show that they are superior as to quality and efficiency; that broadcast listeners are practically unanimous in their choice of this type speaker; that their volume handling capacity is vastly superior to that of the magnetic, and that its sound output is more nearly realistic as judged by those who appreciate real music and speech.



# Speakers Excel Magnetics

## NEGATIVE

*Andrew C. McIntosh*

**A**T FIRST thought it would seem that the question of the superiority of dynamic over magnetic speakers has been settled definitely. And it would be if we were to disregard the relative merits of the two types of speaker and base our judgment solely on the popularity of the dynamic. A little reflection will show that the popular opinion that dynamics are superior rests more on advertising than on the relative merits of the two types.

If we were to base our judgment on present popularity, the dynamic speaker would be far in the lead, but if we are to base our judgment on merits, the question is far from settled. Indeed, arguments have to be advanced to prove that the dynamic is in any way superior to the magnetic, and such arguments are neither plentiful nor conclusive. Many of them are easily refutable.

Before we proceed to prove the equality, if not the superiority, of the magnetic speaker let us define the two types. A magnetic speaker is one in which the armature or moving part is a piece of iron attracted by a varying field, this field being varied by the signal. The steady portion of the field may be produced either by a permanent magnet or by an electromagnet. A dynamic speaker is one in which the armature is a coil carrying the signal current, located in a steady field produced either by a permanent magnet or by an electromagnet. We shall exclude that magnetic speaker in which the field is produced by an electromagnet and that dynamic speaker in which the field is produced by a permanent magnet. That is, we exclude from each type the field which is generally considered unsatisfactory. This can be done without prejudice to either.

### Name Not Essential.

It should be noted that by these definitions the so-called inductor dynamic falls in the class of magnetic speakers. It is clear that the particular name given a variety of speaker does not take it out of one class to put it into another class. The distinction must be based on principle rather than on merchandising expediency.

One of the main advantages of the magnetic speaker is that it is not necessary to provide any devices for producing a field. That is, we do not have to provide a storage battery, a rectifier, or a filter. The field is permanent and steady, and it can be as strong as desired, or as conditions may require to assure a given sensitivity.

Since the field is steady there is no possibility of hum introduction through the field, which is one of the disadvantages of the dynamic speaker. No hum-bucking devices need be incorporated to minimize hum as in the case of dynamic speakers, for the hum is zero from the start. In the practical dynamic speaker there is nearly always a residual hum no matter how well the field current has been filtered or how well the hum-bucking has been arranged. Moreover, if exceptional precautions have been taken to eliminate the hum from the dynamic, the speaker and its associated devices become heavy and expensive, and its sensitivity may suffer at the same time.

The magnetic speaker is simple in construction, inexpensive, and hum-free.

If the magnetic speaker were in any way inferior to the dynamic it would not be used by telephone laboratories, where the finest sound producing equipment is designed and built. The fact that these laboratories still use magnetic speakers where fine quality reproduction is paramount is strong evidence for the superiority of the magnetic. Finely constructed magnetic units attached to long exponential horns are used in equipment turned out by these laboratories, and no expert on sound reproduction has yet been able to say that the quality from this equipment is inferior. Indeed, all the experts agree that there is nothing else quite as good. If there were any chance that the quality could be improved by the use of dynamic speakers, such would be made standard equipment in these reproducing systems. While magnetic speakers are used in these systems we must admit that the experts who know most about sound quality regard the magnetics as superior to the dynamic.

It is said that dynamic speakers are more efficient than magnetic. This is true if we consider the signal only. But the signal efficiency is not the only thing to be considered, especially when any lack of signal efficiency may be offset readily by a little amplification in the circuit. More important is the overall efficiency of the speaker. It may well be that the dynamic speaker will have a field requiring 10 watts. Ten watts for four hours every day will amount to 1.2 kilowatt-hours a month, which at the rate of 7.5 cents per kilowatt-hour will

amount to 9 cents a month. This is not a large amount, to be sure, but it is larger than nothing. The magnetic speaker does not require the extra energy.

The operating power requirement is not the only expense associated with the dynamic speaker. A rectifier is always needed, which may be either of the dry disk, low voltage type or the vacuum tube, high voltage type. In either case the rectifier will break down periodically, requiring replacement. Rectifiers cost money. The permanent magnet in a magnetic speaker may occasionally require remagnetizing but this will cost only a small fraction of what a new rectifier would cost. Moreover, if the magnet is not abused it will retain its strength for years.

### Quality of Output.

The belief that the quality from dynamic speakers is superior to that of magnetic is common. We have already shown that this opinion is untenable. We shall give other reasons. The dynamic speaker invariably requires an input transformer. Every transformer, no matter how good it may be, introduces some distortion. A magnetic speaker may be wound so that it does not require a transformer, and most of this type of speaker are so wound. Thus the distortion introduced by the transformer is prevented by the use of a magnetic speaker.

Low note effectiveness has always been an argument in favor of the dynamic speaker. This argument does not hold when a long exponential horn is used nor when a large cone is employed with a magnetic unit. Low note reproduction is largely a matter of dimensions, and there is just as much room for a large speaker of the magnetic type as for one of the dynamic.

There is another disadvantage of the dynamic associated with low note reproduction. When the speaker is made really effective on the low notes the residual hum from the field is brought out very strongly. Frequently devices are introduced into the speaker for eliminating this effect, which is done by reducing the efficiency on the low notes. In the magnetic speaker the low notes can be brought out in full force without any danger of increasing the hum. It is true that hum originating in the amplifier will come out strong on the magnetic speaker that is effective on the low notes, but not any more so than on the dynamic. As far as this goes, there is a draw between the two types.

### Low Note Capability.

In comparing speakers of the two types we must discuss what might be called low note capability. This refers to the maximum possible swing of the armature, which really determines the volume that may be obtained on the low notes. If the speaker is so constructed that the armature will strike the poles when the volume on the low notes is strong, only a very weak signal can be impressed. If the pole pieces interiere with the movement of the armature the quality will be spoiled by rattling. It is admitted that in most magnetic speakers the low note capability is much less than that in dynamic speakers. This, however, is not serious if a long exponential horn or a large cone is used with the magnetic unit, because the air load on the unit is great enough to prevent any wide excursions of the armature.

It will be remembered that the inductor dynamic speaker is really magnetic. Because of this it partakes of all the advantages of the magnetic and in addition it permits free movement of the armature to the same extent as the dynamic speaker. Therefore the low note capability of the inductor "dynamic" is every bit as good as that of the dynamic.

The efficiency of the inductor dynamic on the low notes is also fully as good as, if not better than, that of the dynamic speaker. Hence this speaker includes the advantages of both types, and it should be remembered that it is a magnetic speaker despite its name.

Much of the prejudice against magnetic speakers is due to the fact that many poor ones of this type have been sold. On the other hand, much of the popularity of the dynamics is due to the fact that most of this type sold have been good in their class. But most of the favorable opinion on these is due to publicity. If a large number of people had really operated first class magnetic speakers, either of the inductor or the exponential horn types, in conjunction with first class amplifiers the magnetic speaker would now be held in higher regard.

This is born out by the fact that many who have tried both types continue to use the magnetic and let the dynamic gather dust. Some of the keenest judges of tone quality cling to the magnetic because the tone is better. These fellows do not jump at conclusions, for when they change from one type to the other they also change the output coupler so that each type will work under the best possible conditions. And are they satisfied with a volume so low that the output is just barely audible? They do not. Many use 250 tubes in push-pull on the magnetic speakers and make them do all of which they are capable. The speaker does not chatter because it is loaded up with long exponential horn or other suitable acoustic transformer.

# A Clinical Study of P

## Blanketing and Follow-Through Tu

By C. M.

[C. M. Jansky, Jr., consulting and radio engineer, made a field study of interference conditions arising from the assignment of WGBS, New York City, to 600 kc, or only 30 kc from WMCA and WNYC, which occupy 570 kc. Mr. Jansky reported in favor of the 30 kc separation, as no serious interference resulted except where inferior receivers were used. He testified for WGBS, before the Federal Radio Commission. The following is the burden of the testimony he gave.—EDITOR.]

RECEIVING conditions as they exist for the listener who resides in the city are radically different from those that exist for the listener who resides more than 50 miles from any broadcasting station. The problem at hand involves receiving conditions as they exist due to the simultaneous operation of two stations in the New York area, the frequency assignments to the two stations being separated by only 30 kc.

Specifically, WGBS, located on the east bank of the East River in Astoria, New York City, is now licensed to use 500 watts power in the day time and 250 watts power at night on 600 kc. WMCA, the transmitter of which is located in Hoboken, N. J., is licensed to use 500 watts on 570 kc., this station dividing time with WNYC, a 500-watt station located in Lower Manhattan, also operating on 570 kc.

I was asked to determine whether or not the operation of WGBS, as it is now licensed, would or would not produce conditions such that radio listeners most likely to receive interference would be unable to receive WMCA or WNYC while WGBS was in operation.

### Classification of Interference

In general, cases of interference may be subdivided into two classes: (a) where stations are assigned to the same channel or frequency; (b) where stations are assigned different channels so separated that crosstalk interference may result in the average receiving set. Heterodyne interference is clearly not involved in this problem. The question which confronted me was whether or not in the average receiving set, under the conditions of operation and geographic location involved, a frequency separation of 30 kc. was sufficient.

Assuming two stations assigned frequencies separated by 30 kc., using approximately the same percentage modulation, then the four factors involved in determining whether or not appreciable interference will or will not result from the simultaneous operation of the two stations are as follows:

- (a) Selectivity characteristics of the average receiving set when tuned to the frequency of the desired station;
- (b) Frequency separation between the interfering and desired station;
- (c) Ratio of the field intensity produced by the interfering station to that produced by the desired station;
- (d) The absolute magnitude of the field intensity produced by the interfering station.

### Modulation Width

Before discussing the effect that each of these factors will have upon a given interference situation it is necessary to consider briefly the characteristics of waves as they are transmitted from broadcasting stations.

If it be assumed that the modulating frequencies present in speech and music are not allowed to exceed 5,000 cycles per second, then the wave radiated from a properly operated radio telephone transmitter will consist of a carrier frequency and two sidebands, the sidebands extending 5,000 cycles above and 5,000 cycles below the carrier frequency. Thus the width of channel occupied by a properly operated transmitter, assuming modulating frequency is limited to 5,000 cycles, cannot under any conditions exceed 10,000 cycles, that is 10 kc.

With broadcast station assignments separated by 10 kc., as is the practice today, it is therefore impossible, under the conditions described above, for the 10 kc. band transmitted by one station to overlap the 10 kc. band transmitted by the station assigned to the adjacent channel, regardless of the power or geographic location of the stations involved, assuming of course that the carrier frequencies are correctly adjusted.

### Broad and Sharp Waves

I wish particularly to emphasize the statement made above because the average radio listener almost invariably refers to the different stations as transmitting *broad* or *sharp* waves, his characterization of the stations depending upon the relative

number of degrees he finds it necessary to turn the dial of his set to eliminate the stations.

For instance, if he finds it necessary to turn the dial of his set 6 degrees to eliminate a station, he will say that the station transmits a *broad* wave, while if he finds it necessary to turn his dial  $\frac{1}{2}$  a degree he will say that the station is transmitting a *sharp* wave. As a matter of fact, all properly operated stations transmit waves that will occupy the same width channel in the ether, the apparent broadness or sharpness depending not upon the transmitter but on the characteristics of the receiving set in use by the listener.

### Ideal Receiver's Action

An ideal receiving set would be one which would admit the particular 10 kc. band for which the receiver is tuned but would completely exclude all other frequencies. Thus an ideal receiving set tuned to 600 kc. would admit all frequencies lying between 595 kc. and 605 kc. and would exclude all others. Actual receiving sets, however, unfortunately, do not possess this characteristic. Thus a receiving set tuned to 600 kc., while it will admit almost as easily frequencies between 595 and 605 kc., will also admit to some extent a frequency of 590 kc. It will admit still less easily a frequency of 585 kc., and so on.

This characteristic which determines the extent to which a receiving set will eliminate frequencies other than that for which it is tuned is known as "selectivity."

### More Circuits, More Selectivity

The selection of one station to the exclusion of others in a radio broadcast receiver is accomplished by the aid of tuned circuits. A tuned circuit usually consists of a coil, coupled to a condenser the capacity of which may be varied by a dial.

Early radio broadcast receivers utilized only one tuned circuit, a certain amount of selectivity being thus obtained. However, when the number of broadcasting stations increased to a point where broadcast assignments 10 kc. apart became necessary, it was found that more tuned circuits were required. These circuits are incorporated with the vacuum tubes used for radio frequency amplification. In general, as the number of tuned circuits in a broadcast receiver is increased the selectivity of the receiving set may also be increased.

In 1926 and 1927 by far the largest number of receiving sets sold were sets using three tuned circuits. While I do not have the actual figures available, it is my opinion that the majority of receiving sets sold in 1929 possessed at least four tuned circuits.

### Sets Have to be Considered

Obviously, before the Federal Radio Commission can determine whether or not particular operating conditions are satisfactory the Commission must determine just what types of radio receiving sets are entitled to protection. This determination must be based upon some knowledge of the types of receivers in use by the public.

It is my opinion that the Federal Radio Commission has a right to expect that the average broadcast listener will have a set using four or more tuned circuits or at least one of the better and more selective three-tuned circuit sets. The listener using an old regenerative set, or a poorly designed, old-style three-tuned circuit set, has no right to expect to be protected from interchannel interference which would not be noticed in a set possessing average selectivity.

Certainly if under normal operating conditions a radio listener located less than one mile from WGBS and using a three-circuit, unshielded radio receiver, such as was manufactured in 1926, finds it possible to receive signals from WMCA or WNYC without interference from WGBS, it cannot be said that the conditions of interference are such that the simultaneous operation of the stations is not in the public interest.

### Interference and Assignments

Because of the selectivity characteristics of receiving sets as I have discussed, the further apart are the assignments to station located in the same geographical area, the less the possibility of interference in the average receiving set. In the case at hand we are concerned with the simultaneous operation of stations separated by only 30 kc. Obviously, there would be less possibility of interference if the separation were 60 kc. and still less if the separation were 90 kc.

There has grown up a feeling that there should be a separation of at least 50 kc. between frequency assignments to stations located in the same geographic area. The origin of this feeling I wish to discuss in some detail.

# Proximate Interference

## Receiving Are Two Types—Remedies Cited

Jansky, Jr.

[Here the author traces the history of a minimum of 10 kc separator between stations in the same geographical locality, it having originated at the Second Radio Conference in 1923, but not being a hard-and-fast rule, but "a guiding principle that does not preclude less than 50 kc separation that would produce interference-free reception.]

Assuming a receiving set possessing a given selectivity in use, the stronger the signal at the receiving location, the more the station must be detuned before the signal will be eliminated. The intensity of the signal at a given receiving location as measured in micro-volts per meter depends upon the power in use at the transmitter but it depends far more upon the distance between the receiver and the transmitter.

Thus increasing the power 10 times at a transmitter will increase the intensity of the signal at any receiving location only a little more than three times, while moving the receiving location from a point one mile from the transmitter to a point only one-fourth mile from the transmitter will increase the intensity of the received signal about the same amount. That is, moving the receiving location three-quarters of a mile would produce an increase in field intensity equivalent to changing the power of the transmitter from 500 watts to 5000 watts, assuming the receiving set to have been kept at the first location.

If a listener desires to receive WMCA to the exclusion of WGBS, then his ability to do so will depend upon the ratio of the intensity produced by WGBS at his location to that produced by WMCA. The higher this ratio, the more difficulty he will have in receiving WMCA, assuming he encounters any difficulty at all. This ratio will, of course, be highest close to WGBS's transmitter. This being true, an investigation of receiving conditions as they exist near WGBS, if it discloses no interfering conditions to exist, is conclusive proof that interference will not exist elsewhere. Because of this fact the studies which I have made were all confined to receiving locations less than a mile from the location of WGBS's transmitter.

### "Blanketing" Interference

Not only is the ratio of intensities of importance in determining whether the distant station may be received to the exclusion of a nearby station, but also the actual value of the intensity produced by the nearby station must be considered. This is due to the existence of a phenomena often referred to as "blanketing."

The presence of large currents and voltages in a set, due to a high field intensity from a nearby station, may destroy the selectivity characteristics of the set. The signal intensities which will produce blanketing will of course depend upon the characteristics of the set in use. Bearing in mind the characteristics of the average set, it seems reasonable to expect that blanketing should not occur except at locations where the field intensity is above 200,000 or 300,000 micro-volts per meter. Blanketing did not exist in a modern broadcasting receiver at a location where the field intensity was in excess of 300,000 micro-volts per meter.

### Clinical Study

There is no better way of determining interference conditions in a given locality than to go directly into the homes of radio listeners and actually determine the conditions of operation of their own receiving sets.

In order to obtain first-hand data relative to whether or not the operation of WGBS, WMCA and WNYC under present operating conditions would result in appreciable interference from WGBS with the reception of programs from the other two stations, I visited the homes of about a dozen radio listeners residing in Manhattan and Astoria.

All of these receiving locations were less than a mile distant from the transmitter, one being only 100 yards away.

If listeners residing less than a mile from stations have no difficulty in eliminating the nearby station in favor of a more distant station it is evident that listeners residing more than a mile away should certainly have no difficulty. Inasmuch as the members of the staff of WGBS had received a few complaints of interference we decided to include these in the list of places to be visited.

While actual studies of receiving conditions in the homes of broadcast listeners yield first-hand information concerning broadcast conditions in a particular locality, it is necessary to know the field intensities produced by the two stations involved as the points of observation, if the information gained by re-

ceiving set studies is to be of any value in determining what can be expected in other localities.

### Field Intensities Measured

Accordingly, having made actual studies of receiving conditions, I made measurements of field intensities produced by WGBS and WMCA at all of the locations at which receiving set investigation had been made with the exception of two. No measurements were made of the field intensities produced by WNYC, it being common knowledge that this station produces larger field intensities throughout the area in question than does WMCA. If interference does result with the reception of the weaker signals from WMCA, it follows that interference will not result in receiving the stronger signals from WNYC.

The apparatus which I used in making field intensity measurements was the same as that which is used by the Radio Supervisors of the United States Department of Commerce. This apparatus was mounted in a truck. The truck was then driven to the various points and the measurements taken. I will give the field intensities in micro-volts per meter, as produced by WGBS, the intensity produced by WMCA and the ratio of the intensity from WGBS to that from WMCA. It will be remembered that the higher this ratio, the greater the possibility of interference and that if using average receiving apparatus at points where this ratio is very high no interference results then certainly no interference would exist using the same apparatus at points where this ratio is low.

### Tells How Sets Behaved

Observation point No. 1 was made at the Yorkville Radio Shop, at the corner of 86th Street and Lexington Avenue. This location is just one mile due west from the transmitter. (WGBS signal 39,200 micro-volts, WMCA 24,000 micro-volts, ratio 1.6) Here four different sets were tested (a) a late made Brunswick using four tuned circuits; (b) a late model Majestic using four tuned circuits; (c) a late model 633 Stromberg Carlson using four tuned circuits and (d) a model 55 Atwater Kent using three tuned circuits. No difficulty was experienced in separating the stations and it was evident that no interference would have resulted even if the ratio of WGBS signal to that of WMCA had been far greater.

Observation No. 2 was made at the Astor restaurant on the corner of Mills street and Astoria Avenue, 1 p. m., just 100 yards southeast of the transmitting antenna, WGBS 344,000 micro-volts, WMCA 3,280 ratio 105). These are extreme conditions under which to expect to receive WMCA to the exclusion of WGBS. This test was made when WGBS was entitled to use 500 watts power during the daytime. The antenna in use had a total length of 50 feet of which 20 feet was flat top.

### The Magic of the Little Condenser

While listening to WMCA, WGBS could be heard in the background sufficiently loud to be objectionable on some programs although not on others. By inserting a small condenser in series with the antenna having a capacity of 100 mmfd., WMCA could be heard without any objectionable crosstalk from WGBS. By listening very carefully at the loudspeaker, WGBS could just barely be heard when the transmitter at WMCA was not being modulated. With the condenser in there was no difficulty in receiving other stations.

Observation No. 3 was made at 2:30 p. m., at the home of Mr. and Mrs. Fitchelman, 322 East 83rd Street, on Manhattan Island. At this point the intensity produced by WGBS was found to be 72,600 mv. p. m., that from WMCA 10,300 mv. p. m., the intensity ratio, therefore, being 7.05. The receiver location is three-fourths of a mile west and a little south of WGBS's transmitter, over half of this distance being over water.

The receiving set in use in this location is a Fada Special battery operated set using three tuned circuits, the condensers being unshielded. I am very familiar with this particular model, having used one in my home in 1926. It is my understanding that this set was manufactured during 1925 and 1926. I believe it to be typical of the three circuit receivers manufactured at that time.

### Poor Quality Traced Down

Using an antenna having a total length of 70 feet, no difficulty whatsoever was encountered in receiving WMCA while WGBS was in operation using 500 watts power. The quality of reproduction, however, from all stations received was very poor and it had been the opinion of Mr. and Mrs. Fitchelman that this poor quality was due to the operation of WGBS. As a matter of fact it was due to the presence of dirt and moisture

(Continued on next page)

# The March "Proceedings"

## A Review of Interesting Papers That Were Written by Experts

**W** C. WHITE, of the Research Laboratory, General Electric Co., Schenectady, N. Y., contributes a paper on the "Standardization in the Radio Vacuum Tube Field" to the March issue of "Proceedings of the Institute of Radio Engineers." He traces the history of the development leading to standardization and gives the present status. Base dimensions, the filament voltage, plate voltage and grid bias voltage are the features that require standardization of the highest degree.

"Graphs of Prof. Sommerfeld's Attenuation Formula for Radio Waves" is the title of a paper contributed by Dr. Bruno Rolf, First Meteorologist, Director of the Geophysical Observatory at Abisko, Sweden. The paper is mainly of theoretic interest to those who are trying to explain mathematically the vagaries of radio wave behavior.

Henry E. Hallborg describes "The Radio Plant of R. C. A. Communications, Inc.," and contrasts the present short-wave plant with the long-wave plant which was the major means of long-distance communication six years ago. Directive transmission and reception are described and graphs given which show the nature of the transmission pattern. The present status of facsimile and photo-radio is also outlined. The paper is illustrated with many photographs of equipment and graphs of characteristics.

### A High-Frequency Transmitter

I. F. Byrnes and J. B. Coleman, Engineering Department, R. C. A.-Victor Company, Inc., Camden, N. J., describe "A 20 to 40 Kilowatt High Frequency Transmitter," giving photographs, characteristics and circuit diagrams. The speed of transmission is as high as 890 words per minute.

A timely paper on "Power Output Characteristics of the Pentode" is contributed by Stuart Ballantyne and H. L. Cobb, Boonton Research Corporation, Boonton, N. J. The paper is principally mathematical, but experimental technique and results are also given to verify the mathematical deductions. Three types of power limitation are classified and discussed: (1) distortion due to curvature of the characteristic; (2) distortion due to plate current cut-off; (3) distortion due to the grid potential becoming positive. The circumstances of the occurrence and their effects are studied qualitatively. The analysis and the experimental results apply to a special pentode, and not the voltage amplifier pentode available on the American market.

An interesting account of "Experiments with Electric Waves of About 3 Meters" is contributed by Abraham Esau and Walter M. Hahnemann, C. Lorenz-Aktiengesellschaft, Berlin-Tempelhof, Germany. This paper should prove of great value and interest to the American radio amateur, since the equipment necessary for transmission and reception is relatively simple and inexpensive, and also since there is very little crowding in this band. Amateurs are permitted to use the 0.75 meter frequency and the paper indicates that it is possible to go down as low as 0.5 meter.

"The maximum range of these waves," the paper states, "depends on the height of the transmitter and the receiver above the surroundings. The ultra-short waves (3 m.) are the most appropriate signaling means for short-distance communication. As far as can be seen at present, they do not have undesirable ranges; within the attainable short ranges they guarantee good reception, without the possibility of disturbances inherent to the long and short waves used up to now.

"As the ultra-short waves may readily be modulated with a very large width of television transmission, they may perhaps some day lead to the practical solution of television transmission."

### Testing Piezo Oscillators

E. L. Hall of the radio section of the Bureau of Standards, Washington, D. C., describes method and apparatus used by the Bureau of Standards in testing piezo oscillators for broadcast stations. The subject is discussed under the following heads: Piezo Oscillators as Frequency Standards for Broadcast Stations; Testing Methods; Description of Apparatus; Operation of Apparatus; Test Procedure, and Conclusion. The measurement of the frequency of a broadcast is done by comparing it with the frequency of a piezo oscillator which is temperature-controlled and of constant and accurately known frequency.

F. Gerth, Laboratory of C. Lorenz Aktiengesellschaft, Berlin, Germany, describes "A German Common Frequency Broadcast System" by which three German broadcast stations are synchronized for simultaneous transmission on the same frequency. Two cables are necessary between stations, in which the carrier frequency is between 1,500 and 2,500 cycles. Multiplication of frequency is accomplished by static frequency changers in three stages.

### Radio and the Weather

In "Weather Forecasting by Signal Radio Intensity," R. C. Colwell, West Virginia University, Morgantown, W. Va., shows by graphic records the relationship between reception and weather conditions. Increasing intensity after nightfall is an indication that the next day will be stormy; decreasing intensity after nightfall indicates that the following day will be clear, and no change in the intensity of the signals received after nightfall indicates no change in the weather. The records refer to KDKA, Pittsburgh, Pa., and Morgantown, W. Va.

An interesting four-element vacuum-tube beat-frequency oscillator is described by S. Reid Warren, Jr., University of Pennsylvania, Philadelphia, Pa. The tube used is a 222 screen grid tube. One frequency is determined by a tuned circuit in the control grid, with feedback from the plate in the usual manner. The other frequency is determined by a tuned circuit in the screen grid lead. Oscillograph records of the beat current show that the wave form, as a rule, is not pure.

## Jansky Reports on Interference Remedies

(Concluded from preceding page)

in the loudspeaker mechanism. After this dirt had been removed the fidelity of reproduction was found to be entirely satisfactory.

Observation No. 4 was made 3:40 p. m., at the home of Mr. J. Doyle, 252 East 77th Street, on Manhattan Island. The receiving set installed at this location was a Lang set operating directly off the 110 volt DC supply system. An antenna having a flat top length of some 80 feet was in use and although there were two antenna posts, one for a long antenna and the other for a short antenna, the long antenna had been connected to the short antenna post. Upon test it was found that all stations received could be heard over a comparatively large portion of the dial. This portion of the dial was larger the more powerful the station.

The tuning characteristics of this set show why the average listener assumes that some radio broadcasting stations are sharp while others are broad. The results obtained by tuning this receiver were of such interest that I have recorded them in detail. The receiver dial had 100 divisions. WMCA could be heard anywhere between the 100 and the 75 division markings, WGBS anywhere between 95 and 64, WEAFF between 60 and 76, WOR between 52 and 67, WJZ between 45 and 55, WABC between 32 and 38.

It can be seen that WMCA could be heard over 25 divisions,

WGBS over 40, WEAFF over 16, WOR over 12, WJZ over 10, and WABC over 6. The average listener, attributing the characteristics of his receiver to the transmitters would say that WGBS, since it could be heard over 40 divisions, was approximately seven times as broad as WABC which could be heard over only 6, whereas, as a matter of fact both stations occupy the same width channel, namely, 10 kilocycles.

Obviously, a receiving set, the selectivity characteristics of which are such that a station like WJZ 30 miles away could be heard over 10 divisions and other stations over still wider portions of the dial, cannot be considered as sufficiently selective for modern conditions.

However, inasmuch as the volume obtained from this set was far too great for comfortable reception even with the volume control in its minimum position it was quite obvious that the antenna was far larger than that for which the set had been designed. Disconnecting this antenna and substituting a smaller one reduced all signals to a satisfactory volume, yet permitted reception of any station and at the same time made the set sufficiently selective so that WMCA could easily be heard at the exclusion of WGBS. At this location WGBS was producing a signal intensity of 68,600 mv. p. m., WMCA an intensity of 9,200, the ratio being 7.45. The receiving location is seven-eighths of a mile southwest from WGBS's transmitter. The Lang receiver utilizes three tuned circuits although I understand this receiver is of fairly recent design.

# An Extra Good A Supply

## Eliminator Delivers up to 2½ Amperes Without Hum

By S. William John

I HAVE received several requests during the past two weeks from readers for a description of a good A eliminator, and I have had the idea in mind for some time previously to discuss this subject. The DC output capacity of the eliminator I am about to outline is flexible, but its maximum output voltage for continuous operation is in excess of most commercially available devices of this character.

The principal parts do not differ so widely from ordinary eliminators, and consist of a step-down transformer (110 volts to 20 volts), two 15-volt mfd, 2,000 unilateral condensers, either dry or liquid type; a choke inductance, which may be home-made, and the necessary wiring, binding posts and a 6-ohm controlling resistor that is variable and will carry at least two to three amperes without excessive heating, and finally a large surface dry rectifier, made by combining at least four similar commercial rectifiers in parallel circuit.

It is customary to begin about here to give a constructional description but I want to say something more important first.

### Something Extra Good

The chief reason why most of us want to build our own apparatus, whether from assembled parts or home manufactured ones, is that we believe that we can build something better suited to our own individual needs than is possible to buy commercially made up, and in this instance it's certainly very true as most manufacturers are only furnishing apparatus to fill a definite and prescribed requirement, whereas the home builder finds out that as his experimental activities begin growing the need for more flexible apparatus and facilities to meet either more exacting tests or tests that require more energy. The usual types of A eliminators do not come up to the standards of the device at present under discussion.

Commercially made A eliminators have a bad tendency of causing a hum in the loudspeaker toward the end of their useful life, which, too, by the way is often cut short by untimely overheating of the rectifying unit, due either to improper adaptation of the device to the load which it is supposed to carry, or breakdown of the unilateral condensers, due to excessive pulsating component. So there are a few pointers here on the pitfalls to avoid, and nearly all of them point to the need of arranging a design that is ample in every respect to *average* requirements rather than a device that is skimpy.

The step-down transformer TR must be operative on whatever frequency coincides with the local legiting supply lines. A 25 cycle transformer will be found to be larger than one of similar rating for 60 cycles. C<sub>1</sub> and C<sub>2</sub> are two 2,000 mfd unilateral condensers with an 18 volts maximum peak voltage rating. C<sub>3</sub> is a 2 mfd bypass condenser.

The parts marked A are four dry rectifiers. These should be new ones. When the circuit is made up and connected as shown, viz., all AC terminal in parallel and all (+) terminals together and all (-) terminals together, the grouped DC connections are then led to the filter choke and from here to the binding posts the circuit is self-explanatory.

### Directions for Making Choke

The only unexplained part now is the choke L<sub>1</sub> and I am going to describe a design that will have ample iron for those builders who line in 25 cycle areas, so the same choke (but different transformers) should be used for 25, 40 or 50 cycles. Obtain enough transformer "E" iron of .014" thickness, made from good silicon sheet stock, and have the window (or winding space "half") measure 1½" x 3½". These dimensions will allow enough room for windings and insulation for 60 cycle to 25 cycle circuits. Of course it must be realized here that as we use full-wave rectification the

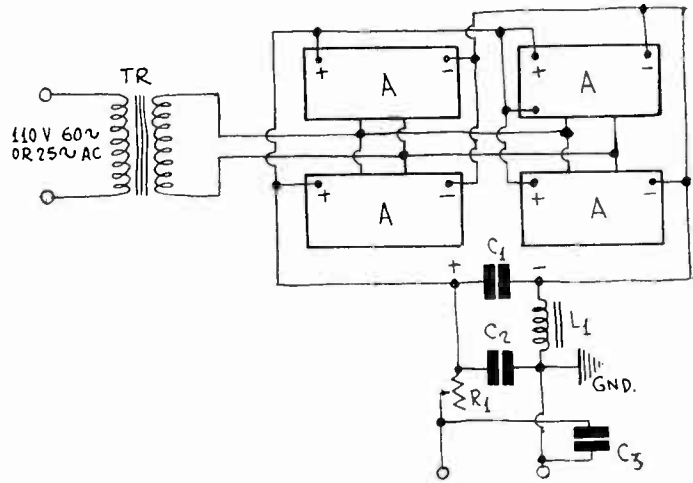

THE CIRCUIT DIAGRAM OF THE "A" SUPPLY

pulsating DC component will be 120 beats per second and 50 beats per second, respectively.

Now the winding on the choke coil is to be made with No. 16 plain enamel wire and will consist of 16 layers of 52 turns per layer, making a total of 832 turns, if the coil is wound full. This allows 1/16" for core, and coil end insulation pieces and the only variable left is the thickness of the core. Make the core about 2" thick. These data are for home-making of the choke, but the same results can be obtained from the slightly differently made Polo A-E choke.

I have one of these eliminators operating as a source of A voltage on a Superheterodyne and its output under 2½ ampere load is humless, and has been so for a year. Also, the operating temperature is very low, due to the generous dimensions of all parts, but as results are what finally count, this over-sized storage battery substitute is a real asset.

### Some Data on Prices

The controlling resistance, R<sub>1</sub>, is a 6 ohm variable, one that should carry at least 2½ amperes without getting excessively warm. This eliminator can be used to furnish current for a wide variety of uses, where a smooth steady flow is important.

The transformer should cost around \$2, the choke (built up) about \$6.25, the 2,000 mfd, \$4.50 each. Four are needed, as these will run into some money, \$15 or so for all four. The "rab" curves in at + the rectifiers kuprox 16 disc 2 x 2" works well.

### LIST OF PARTS

- T. R.—A 110 volt to 20 volt step down transformer. (Specify whether for 50, 40 or 25 cycles, 25 cycles can be used on 40 cycles.)
- L1—A choke made up as per instructions, or a Polo A-E choke.
- C1, C2—Two Flechtheim 2,000 mfd unilateral condensers.
- C3—One 2 mfd. by-pass condenser.
- R1—A 6-ohm variable resistor, capacity 2½ amperes.
- Two insulated binding posts and necessary connecting wire.

# Spreckels Made \$12,908,612 on Kolster Stock

The net profit by Rudolph Spreckels of San Francisco, chairman of the board of directors of the Kolster Radio Corporation, in the sale of Federal-Brandes and Kolster stock during 1927, 1928 and 1929, amounted to \$12,908,612, it was revealed in a statement filed in Newark by his attorney, Walbridge Taft, and submitted at the last of a series of hearings held by John A. Bernhard, special master appointed to investigate the charges made by Albert Schwartz that someone had

"rigged the market" in the sale of Kolster stock.

Mr. Taft also announced that plans for the reorganization of the company were being worked out and soon will be made public.

The statement showed that Mr. Spreckels made a profit of \$117,668 in 1927, \$14,284,824 in 1928, and that he lost \$1,493,880 in 1929 in the purchase and sale of Kolster stock. These figures are before income taxes. The total purchases of

Kolster stock by Mr. Spreckels were 388,004 shares, at prices ranging from \$10 to \$84.25 per share. From November, 1927, to December, 1929, he sold various amounts of Federal Brandes and Kolster stock at prices ranging from \$6.38 to \$84 per share. He now holds, the statement said, 57,246 shares of preferred stock and 18,219 shares of common stock, which makes him the principal holder of the common stock in the Kolster Radio Corporation.

## MORE STATIONS ON SAME WAVE, PLEA TO BOARD

Washington.

In a brief filed with the Federal Radio Commission in behalf of WBBM, of Chicago, simultaneous operation of high-powered broadcasting stations on opposite sides of the country on cleared channels of identical frequency, as a means of relieving congestion in the broadcast band without conflicting with sound engineering practice, is recommended to the Commission.

This would enable the Commission, according to the brief filed by Littlepage & Littlepage, counsel for WBBM, to assign 10 additional assignments of high-powered stations, which could be assigned to certain states in the Middle West, notably Wisconsin and Indiana, which they do not now have but to which they are entitled, without taking away from the Chicago area any of existing stations. Chicago is entitled to two cleared channels and now has four and four-sevenths of the eight channels designated for the entire fourth zone.

The attorneys suggested the division of the country into what they termed its three "natural zones," the Atlantic coast, the Mississippi Valley, and the Pacific coast. Under the present law the country is divided into five zones, on the basis of population, and provides that the available broadcasting facilities be divided equitably among these zones. According to the Commission's record the facilities have not been divided in this manner, the attorneys for WBBM contends.

"Your applicant contends," the brief states, "that nowhere in the radio act of 1927 or in the amendments thereto has the Congress made any references to cleared channels, that the establishment of such cleared channels is not required or specifically authorized by law, and that, consequently, the establishment of such cleared channels and the attempt to allocate them equally among the five zones has in fact no foundation in the law."

### S-M SALESMEN COMPLETE TOURS

H. C. Bodman, H. W. Sams and D. S. Hill, sales heads of Silver-Marshall, Inc., Chicago manufacturers of Silver Radio and the S-M parts, have completed tours of three sections of the country.

### Asks Reasonable Expectations

**T**HOSE unappreciative of RADIO WORLD's qualities are indeed hard to please. I for one do not expect one radio magazine to supply all my requirements, though RADIO WORLD certainly does its part, in supplying the experimenter, the more technically inclined, the novice and the news hound.

Now you would-be howlers, lay off RADIO WORLD! Remember there is only one radio weekly, and though it may not always suit your or my fancy in some of its issues, remember it is only one week until there is another copy at your door, and mayhap, through the generosity of the editors, it will contain the much-wanted articles.

Also you would-be DX hounds take notice, before you condemn the circuits published in RADIO WORLD, or the manufac-

## Radiovisor Announced

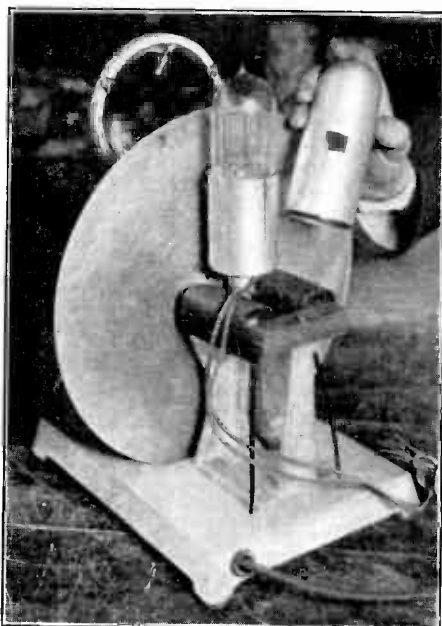

VIEW OF THE JENKINS DISC, MOTOR, LAMP AND LENS

Aiming to provide the average radio experimenter with a device affording results in radio television reception, yet permitting of subsequent alterations and additions, the Jenkins Television Corporation of Jersey City, N. J., announces its Model 100 Radiovisor. This device includes scanning disc, motor, lamp and magnifying lens for the reception of standard 48-line, 15 pictures per second radiovision signals.

Attachments available in the future will permit of receiving other standard signals.

The motor of the Jenkins radiovisor is of the Faraday eddy current type, comprising six electromagnets operating in conjunction with a toothed rotor and copper disc, a synchronous motor for automatic synchronization when used on the same AC power system as the radiovision transmitting station. A speed control permits of slight variations in speed, so that the scanning disc may be synchronized.

## DeForest Company Has New Treasurer

Following a special meeting of the Board of the DeForest Radio Company on March 21st, James W. Garside, President of the Company, announced the election of Oscar Monrad, President of the Ampco Twist Drill Company, as Treasurer and Director of the DeForest Company. The Board also elected William J. Barkley, Vice-President; Dr. Lee DeForest, Vice-President in charge of research; and Allen B. DuMont, Vice-President in charge of engineering.

## BOARD DEFIED BY MICHIGAN; ARRESTS LOOM

Washington.

The State of Michigan has challenged the right of the Federal Government to say who shall operate a radio station. The Michigan Legislature has ordered police wireless, and Governor Green says that he shall proceed to carry out the mandate of the Legislature.

The Radio Commission has announced that it has asked the Department of Justice to instruct the department's agents in Michigan to arrest any person who starts work on the police radio station without a construction permit from the Commission. To this the Governor replied:

"Regardless of threats of arrest, the State will proceed with the construction of the station. The Legislature has stipulated that a station be established and appropriated funds for its construction.

We expect to carry out the mandate of the Legislature."

### Board Members Surprised

The Commission's brief reply was: "The matter is now in the hands of the Department of Justice."

Members of the Commission said they were surprised that Governor Green had decided that he would make an issue of the case, since he had everything to lose and nothing to gain by refusing to await the results of a hearing on the application of the police station for a wave, which has been set for May 15th. Nevertheless the Commission wanted to make this a test case, since it is the first open defiance of the regulation requiring a construction permit.

### Legal Phase

The Michigan contention is that the police power, vested in the State, permits the adoption of all necessary measures to enforce that power including the tracking of criminals by radio communication. The Commission contends the radio law, under the commerce clause of the Federal Constitution, reserves radio station licensing and control exclusively to the Federal Government.

### LITERATURE WANTED.

Irving Olson, 879 Raymond St., Akron, Ohio  
Kenneth W. Meyer, 875 Myrtle Ave., Bridgeport, Conn.  
Clyde Hunsicker, 89 Ramona Ave., San Francisco, Calif.  
H. H. McLeod, 4807 Ash Lane, Dallas, Texas  
Laurence Cord, 3114 W. 56th St., Cleveland, Ohio  
H. Haight, 3761 Wade St., Venice, Calif.  
Ernest Coler, 11 McLean Ave., Highland Park, Mich.

## Forum

tured sets that you say are no good for distance, be sure that the fault doesn't lie at your own door. What do you expect, anyway. California in the daytime from New York or Pennsylvania? You do not expect your automobile to make 200 miles per hour because some speed maniac goes that fast, so why expect too much of your radio?

I have raised California on three tubes, and WD11s at that, with the station power of 200 watts, but that wasn't done

this year or last year, and you cannot expect it next year.

In regard to calling a receiver a nine or ten-tube affair when really it only has seven or eight receiving tubes, why not also count the lights in your home or the pilot light, and make it an even more powerful affair? I have only a seven-tube receiver, and all tubes are all worked at peak efficiency. It also contains two rectifier tubes and a pilot light, and they have sufficient work, too, and I believe that I know how to operate it efficiently, but I don't get KFI or KNX every night, and I don't believe there is any other make or type that can do so, conditions being the same.

Keep up the good work, Mr. Editor, and let the knockers knock.

I. V. FREEMAN,  
Amory, Miss.

# RCA GIVES BEST 'FAUST' SO FAR ON AIR IN U. S.

By EDWIN FANCHER

"Faust," Gounod's most popular opera, was put on the air in condensed form recently by RCA-Victor with no intention of hindering the sale of the tube organization's products. First-rank singers did the singing, and highly capable actors did what acting was necessary to carry along the story in gaps between songs. This method of division of work, and multiplication of effectiveness, is something RCA-Victor was first to introduce in any grand-scale air event. The device of having an announcer spin the yarn's connecting stretches slumped almost into impropriety as soon as the newer method was presented suddenly to the whole country.

Many regard "Faust" as the most melodious opera, because it has such a profusion of equally melodious passages, which account largely for its popularity even with those who are not opera-minded. At least ten different airs strike familiarly on the ears of almost anybody of high school age or over.

### Who Was What

This second of a series of broadcasts by the sponsors of opera in combined concert and continuity form was heard on a coast-to-coast network of forty-six stations of the National Broadcasting Company, with WEAJ, New York City, as the outlet. The rendition was in the WEAJ studio, and the acoustical result, in voice and orchestra, was excellent on space radio reception.

The singing parts were rendered by the following:

Editha Fleischer, soprano of the Metropolitan Opera Company, as Marguerite. Armand Tokatyan, Armenian tenor, of the Metropolitan Opera Company, as Faust; Leon Rothier, bass, of the Metropolitan Opera Company, as Mephistopheles. Theodore Webb, baritone, as Valentin. The spoken or "acted" parts were played by: Rosaline Green as Marguerite; Allyn Joslyn, as Faust; Charles Warburton, as Mephistopheles. Besides, there was a chorus of sixteen voices, and a large orchestra, directed by Nathaniel Shilkret.

The presentation lasted a brief hour, the seeming brevity being the highest form of compliment. The Ballet waltz, that tempts even old legs to dance, was the opening piece, being followed by the foreboding overture that predicts the tragic end. Walpurgis Night shone forth in all its lively splendor as a contrast to the direness to come.

### The Action of the Opera

The story of "Faust" is based on Goethe's work, and deals with the Devil's agent endowing the aged Faust with youth, in return for Faust's surrender of his soul. Faust meets Marguerite, beautiful maiden, and betrays her while her brother Valentin is "off to the wars." On returning Valentin is killed by Faust in a sword duel, and with his dying breath bitterly puts a curse on his sister to her sobbing face. A baby is born to Marguerite, she is sent to prison, Faust visits her there to find her insane and himself unrecognized by her, and she dies in his sight, being transported to heaven by

## WMAQ to Try "Talkie Vision"

Chicago.

WMAQ is installing television transmitting equipment and expects to institute a regular daily service by the middle of June.

The Television signals will be transmitted over short-wave station W9XAP on 6,040 kilocycles while the sound signals will be sent out on WMAQ's regular broadcast frequency, 670 kilocycles.

According to present plans, television presentation of some of the regular sound programs will be made daily.

angels, while the Devil's agent, Mephistopheles, claims Faust as his own.

The story was effectively carried forward by the actors or speaking performers, but of course if one depended on the singers for an understanding of what was going on, even if one knows French, the language of the opera book, and in which the parts were sung, there would be little gleaned. That does not matter, since custom has highly dignified independence of the singer from any requirement save singing very well, and vocally the singers did themselves proud. "Salut Demeure, Chaste et Pure," the most difficult tenor piece, and perhaps the only difficult tenor requirement in this smooth opera, was expressed pulsingly by Tokatyan, whose voice rang with a zealot's fervor. This is Faust's apostrophe to Marguerite's simple but pretty garden dwelling and her virtuous life. This was before, not after.

### Shines in Jewel Song

One of Faust's devices is to leave a casket of jewels in the garden, and Marguerite, while he is hiding, finds them, and sings the precious jewel song, which Miss Fleischer embellished with her skillful freshness.

Miss Fleischer and Mr. Tokatyan teamed superbly in the duet numbers. "Laissez-moi Contempler Ton Visage," a love song of catchy beauty, stood out as if to corroborate the assertion of devotees of heavy opera that "Faust" is fatal with catchiness, whereas melody should be only an incidental of an opera, instead of its ruling impulse.

Mr. Rothier is an adept Faust and a fine actor, besides, yet it so happened that Faust the Actor (Mr. Warburton) did all that Mr. Rothier could have done—he was just splendid. Nevertheless it was well Mr. Rothier did the bedevilled singing. The old master stood out as is his traditional way with the Mephistopheles role. And of course his French was just delicious and should have made the other singers jealous, but surely did not!

Miss Green, who acted as Marguerite, is well known for her dramatic work for the National Broadcasting Company and in the Eveready Hour. She had her practical schooling with the WGY Players and she is a dependable performer.

### Trade Note

For its operatic presentations RCA deserves more praise than it will receive. It can be forgiven now for its self-regretted Clause Nine in license contracts to set manufacturers, attempting to compel use of only its tubes for initial equipment of licensed sets. RCA can do things better than almost any other, and, sad to relate worse than any other, too. If the opera presentations help sell more RCA tubes even an independent tube manufacturer (if enough of a music lover) should have no regrets. But you can't depend on these independents!

Anyway, it was the air's best "Faust" so far.

# PRICE DICTATES SALES OF SETS, SAY DEALERS

Washington.

That price was one of the primary factors influencing the sales of radio sets was revealed in a survey conducted by the electrical equipment division of the Department of Commerce, according to a statement by M. T. Jones, chief of the division. The survey covered the operations of forty-four representative retailers.

Twenty-one of these dealers said that price was the deciding influence in sales; seven stated that tone quality was the primary factor, while five said that appearance came first, according to Mr. Jones.

### Various Ranges of Sales

The retail value of the sales during the year ranged from \$1,500 to \$800,000 per store. Only two stores reported selling more battery sets than electric sets and one store reported selling an equal number of each kind. The electric sets sold were 6.3 for every battery set sold, and the total number of electric sets was 30,000.

In the eastern part of the United States most of the sales were made after 6 p. m., but this did not hold true in the western states.

### Man the Aggressor

While the dealers were asked to report on the proportion of sales made to man and wife jointly and to man or wife independently, the reports did not bring out a clear line of demarcation. However, the report indicated that the man made more independent purchases than the woman.

Nearly all the reports indicated that local newspapers were used by the retailers to promote sales. But other advertising media were also used to some extent, such as direct mail, radio broadcasting, and billboards.

## Two Changes Made On Station Lists

Washington.

The call letters of WJBS, Jersey City, N. J., were changed to WHOM, and KFQZ, the Tait Radio and Broadcasting Corporation, Inc., has had its license renewed.

The new listings follow:

Station	Location	Power	K.C.
WHOM	Jersey City, N. J.	250	1450
KFQK	Los Angeles, Calif.	250	860

[Make these corrections on lists published last week, issue of March 29th.—Editor.]

## New Corporations

Radio Attractions, broadcasting—Atty. Monroe & Byrne, 50 Broadway, New York, N. Y.

Tuxedo Radio Co.—Atty M. Resnick, 280 Broadway, New York, N. Y.

Fredbern Radio Corp.—Atty. Arbean & Fink, 125 W. 45th St., New York, N. Y.

Berkey's Radio Corp.—Atty. Lee, Brewster & Johnston, Syracuse, N. Y.

Square Radio Stores—Atty. S. V. Ryan, Albany, N. Y.

Louis S. Simon Radio Service—Atty. J. J. Levine, 1527 Pitkin Ave., New York.

Pioneer Radio Cast Service Co., Inc.—New York, N. Y.—U. S. Corp. Co., Dover, Del.

National Radio Society, Inc., Broadcasting, Wilmington, Del.—Colonial Charter Co., Wilmington, Del.

Sydmun Radio and Auto Accessories—Atty. S. Guterman, 1440 Broadway, N. Y.

Fred Del Sordo, Inc., Union City, manufacturer radio tubes—Atty. Samuel Moskowitz, Union City, N. J.

Portable Type  
**VOLTMETERS**  
for Measuring High Voltages, In-  
cluding Those of B Supplies.

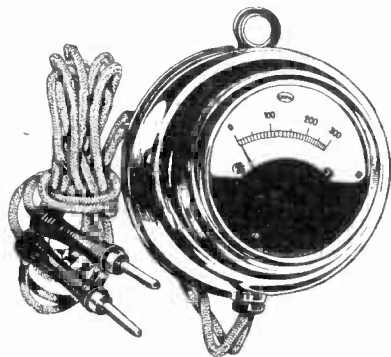

0-300 volts, at 200 ohms resistance per volt, 5 ma. drain at full-scale deflection. Accuracy, 2%. Case is full nickel finish. Long connecting cords have especially ornamental tip holders. Meter should be read in perpendicular position. Five-day money-back guaranty. Order Cat. F-300 @ \$2.59.

0-500 volts, same as above in appearance, but the range is greater and the resistance per volt is 233 ohms., 4 1/2 ma. drain at full-scale deflection. Accuracy, 2%. Five-day money-back guarantee. Order Cat. F-500 @ \$3.73.

0-600 volts, AC and DC (same meter reads both types). DC readings accurate to 2%, also AC readings 2% at 50-60 cycles but accuracy is less on AC at substantially different frequencies.

Resistance 100 ohms. per volt, 10 ma. drain at full-scale deflection. Same general appearance as illustrated meter. Five-day money-back guarantee. Order Cat. M-600 @ \$4.95.

GUARANTY RADIO GOODS CO.  
143 West 45th St., New York, N. Y.  
(Just East of Broadway)

Please ship C.O.D. the following makes, at advertised, on 5-day money-back guaranty:

- Cat. F-300 at ..... \$2.59
- Cat. F-500 at ..... 3.73
- Cat. M-600 at ..... 4.95

Name .....

Address .....

City ..... State .....

**MORECROFT**

New second edition of "Principles of Radio Communication," by Prof. John H. Morecroft, of the Electrical Engineering Department of Columbia University and past president of the Institute of Electrical Engineers. This is an outstanding and authoritative book on the subject.

This large book on radio principles and practice is something that you must not be without. Every set builder, every designer, every engineer, every service man, simply must have this book. Ready reference to all intricate problems makes this volume invaluable. Set builders, experimenters, distributors, dealers, salesmen and teachers, students and operators, all find Morecroft their standby, and now the new second edition awaits you. 1,001 pages and 87 illustrations in this cloth-bound volume

Price ..... \$7.50

**RADIO WORLD**  
145 West 45th Street  
New York City  
(Just East of Broadway)



Your Choice of  
**These Nine Meters FREE!**

- 0-6 Voltmeter D.C. .... No. 328
- 0-50 Voltmeter D.C. .... No. 327
- 6-Volt Charge Tester D.C. .... No. 23
- 0-10 Amperes D.C. .... No. 328
- 0-25 Milliamperes D.C. .... No. 326
- 0-50 Milliamperes D.C. .... No. 326
- 0-100 Milliamperes D.C. .... No. 326
- 0-300 Milliamperes D.C. .... No. 326
- 0-400 Milliamperes D.C. .... No. 324

**Aristocrat Floor Speaker**

With Milled Wood Horn of 8 ft. tone travel (exponential type) with baffle and horn motor built in. Extraordinary bargain. **\$12.00**

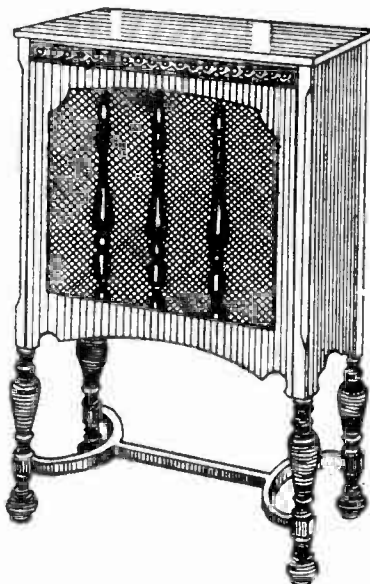

The speaker cabinet is walnut finish, 33" high, 24 1/2" wide, 17 1/2" deep, with carved legs. Golden cloth grille covers front opening. Built inside is No. 595 molded wood horn with baffle and No. 293 driving motor unit that stands 250 volts without filtration. Horn and motor removable. Table alone is worth price asked.

Shipped C.O.D. if desired.

**Acoustical Engineering Associates**  
143 WEST 45th STREET NEW YORK CITY

**TRIAL SUBSCRIPTION, 8 WEEKS,**  
\$1.00. Send \$1 and we will send you Radio World for 8 weeks, postpaid. **RADIO WORLD, 145 West 45th St., N. Y. City.**

**Equip Yourself Now  
With Necessary Meters!**

To do your radio work properly you need meters. Here is your opportunity to get them at no extra cost. See the list of nine meters at left. Heretofore we have offered the choice of any one of these meters free with an 8-week subscription for RADIO WORLD, at \$1, the regular price for such subscription. Now we extend this offer. For the first time you are permitted to obtain any one or more or all of these meters free, by sending in \$1 for 8-week's subscription, entitling you to one meter; \$2 for 16 weeks, entitling you to two meters; \$3 for 24 weeks, entitling you to three meters; \$4 for 32 weeks, entitling you to four meters; \$5 for 40 weeks, entitling you to five meters; \$6 for 48 weeks, entitling you to six meters. Return this offer with remittance, and check off desired meters in squares at left.

RADIO WORLD will help you in your radio work, so you will be able to use the meters most valuably. Keep abreast of all the new circuits, intimate details on perfecting existing sets, and get inside track on sensitivity, distance reception, tonal quality, and news of radio, technical and non-technical. Enjoy the writings of Dr. Lee De Forest, McMurde Silver, J. E. Anderson, Herman Bernard and a host of other radio engineers who contribute their knowledge to you through the medium of RADIO WORLD, the first and only illustrated national radio weekly. You can find no magazine that better caters to your needs than RADIO WORLD. Short waves? RADIO WORLD will tell you all about them. Extremely sensitive broadcast receivers? Their construction and operation are fully discussed with confident regularity. Power supplies—push-pull or otherwise? AC receivers? Screen grid tubes? Large receivers that give a super-abundance of performance—small, economical receivers that give performance out of all comparison to their size? Are you interested in these? Then you're interested in RADIO WORLD.

Present mail subscribers may renew their subscription under this remarkably generous offer. Put a cross in square.

**RADIO WORLD**

145 W. 45th St., N. Y. City—Published Weekly.  
All Newsstands, 15¢ per copy—\$5. six months—\$8 a year

BRILLIANT, NEW

**NATIONAL**

MODERNISTIC PROJECTION DIAL  
WITH RAINBOW FEATURE

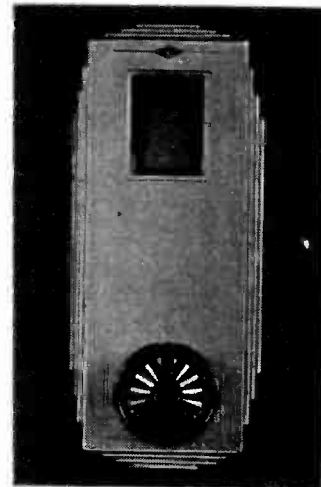

Modernize the appearance of your receiver by installing the brilliant new National dial, with color wheel built in, so that as you turn the dial knob one color after another floods the screen on which the dial numbers are read. On this screen the numbers are projected, so that you get the same dial reading from any position of the eye. This is just what DX hunters want—laboratory precision of dial reading.

The escutcheon is of modernistic design. The Velvet Vernier mechanism drives the drum superbly. Order today. Remit with order and we pay cartage. Shipments day following receipt of order.

GUARANTY RADIO GOODS CO.

145 W. 45th St., N. Y. City (Just E. of B'way)

Enclosed please find \$3.15 for which please send me dial marked below:

- Cat. HC6, National modernistic drum dial, with color wheel built in, pilot bracket, 6-volt pilot lamp for storage battery or A eliminator sets; hardware; instructions ..... \$3.15
- Cat. HC2 1/2, same as above, but with 2 1/2-volt AC pilot lamp ..... 3.15
- Order C.O.D. and I pay cartage.

NAME .....

ADDRESS .....

CITY ..... STATE .....

**TWO FOR PRICE OF ONE!**

Radio World, 52 issues, and Radio News, 12 issues, in combination for special \$7 subscription price. Radio World, 145 W. 45th St., N. Y. City.

**Hi-Q 30 Wholesale Prices!**

AC OR BATTERY MODEL

Write or wire!

Guaranty Radio Goods Co.  
143 West 45th St.,  
New York City



# Tone That Thrills!

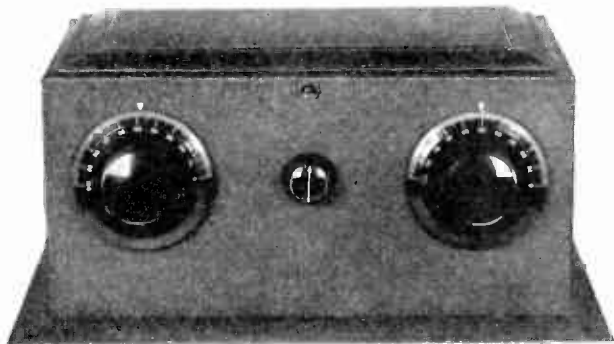

Build the  
HB Compact  
(Battery model)

**\$18.55**

Front view of the HB Compact, battery model, the simple 4-tube receiver that works a speaker at high volume and produces tone that is of the very purest kind. Cabinet is only 15" wide, 9 1/2" front to back, 7" high.

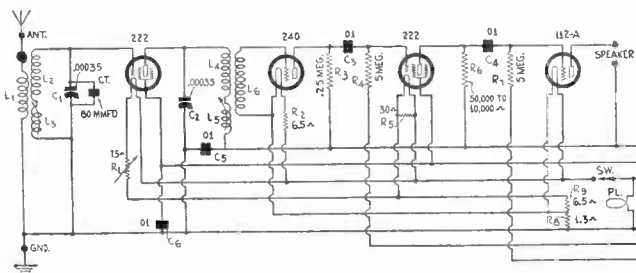

Follow this diagram of the HB Compact, battery model, when building this tone-marvelous receiver.

Everybody is delighted with the exquisite tone of the HB Compact, battery model. "Never heard anything like it," is the usual comment. The receiver uses a 222 screen grid tube for RF, 240 bias detector, 222 first audio and 112A power tube. Draws only .75 ampere filament, 18 milliamperes plate current. Very economical to run. B batteries last 6 months or more. Plentifully selective and sensitive. Build it now!

## LIST OF PARTS

[Check off what parts you want]

- L1L2L3—Antenna coil, BT3A..... 1.35
- L4L5L6—Interstage coil, BT3B..... 1.35
- C1, C2—Two .00035 mfd. brackets..... 2.00
- CT—Hammarlund 80 mmfd..... .35
- C3, C4, C5, C6—Four .01 mfd. mica fixed..... 1.40
- R1, SW—75 ohm switch rheostat..... .80
- R2, R9—Two 6.5 ohm filament resistors..... .50
- R3, R4, R6, R7—.25, 5.0, 0.05 and 5.0 meg. with 4 mounts..... 1.65
- R5—30 ohm filament resistor..... .45
- R8—1.3 ohm filament resistor..... .20
- Ant., gnd., Sp. (+), Sp. (—)—Four posts..... .40
- PL—Pilot lamp 6v. and bracket..... .70
- Drilled, socketed steel subpanel 9 1/2 x 14 1/4..... 2.00
- Crinkle brown steel cabinet, 7 x 9 1/2 x 15..... 3.50
- Two metal links..... .20
- Seven leads for battery cable..... .70
- Two Dials..... 1.00
- All parts..... \$18.55
- Tubes: two 222., one 240, one 112A..... \$ 5.79

The HB Compact, battery model, designed by Herman Bernard, has tone quality second to none. All who appreciate music will revel in the delightful tone of this amazing circuit.

Send in your order for parts today to Guaranty Radio Goods Co., 143 West 45th Street, New York, N. Y., just E. of B'way. Use Coupon.

Name .....

Address .....

City .....

Guaranty Radio Goods Co., 143 West 45th St., New York.

# New AC Screen Grid Short-Wave Adapter

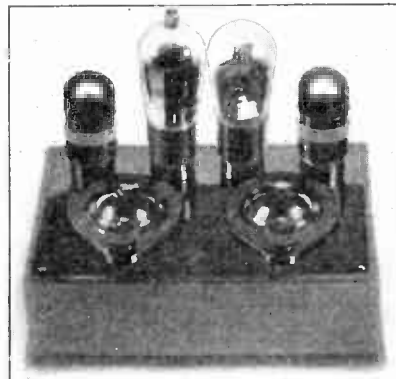

For use with AC screen grid sets only.

## Order what parts you want.

- C1, C5—Two short-wave tuning condensers @ \$1.50..... \$ 3.00
- C2—One .00025 mfd. fixed condenser..... .25
- C3, C6—Two 1 mfd. bypass condensers @ \$.50..... 1.00
- C4—One .01 mfd. mica fixed condenser... .35
- CT—One Hammarlund 80 mmfd. equalizing condenser..... .35
- R1—One Electrad 800 ohm. wire-wound biasing resistor..... .20
- Ant., Gnd.—Two Eby binding posts..... .20
- Two sets of short-wave plug-in coils, three coils to a set, @ \$1.50 a set, total six coils..... 3.00
- One AC short-wave adapter cable, 5-prong..... 1.50
- Two four-prong sockets..... .40
- Two five-prong sockets..... .40
- One grid clip..... .06
- Two dials @ \$.50..... 1.00
- One panel and cabinet..... 3.00

- All parts..... \$14.71
- 227 tube..... .90

## GUARANTY RADIO GOODS CO.

143 West 45th St. New York, N. Y.

- Please ship C.O.D. all parts for AC screen grid short wave adapter @ \$14.71.
- If 227 tube is desired also, put check here.
- Please ship C.O.D. only those parts noted separately.

Name .....

Address .....

City .....

# High Impedance Audio Transformers (Four Thousand Turns on the Primary)

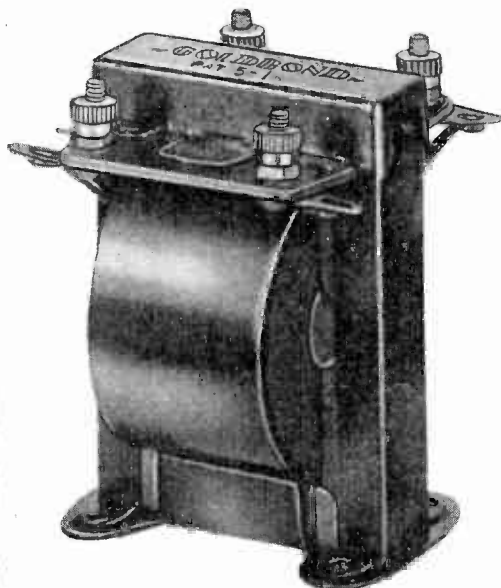

Gold Bond audio frequency transformer is shielded

Gold Bond shielded type audio frequency coupling transformers with high impedance primaries and secondaries are made in two ratios. These are 1-to-3 and 1-to-5, primary to secondary.

A single stretch of copper wire without soldered connections of in-between joints is used for each winding. 4,000 turns on the primary, so the 1-to-3 model has 12,000 secondary turns and the 1-to-5 model 20,000 secondary turns. The overall height is 3 inches and the surface occupied is 2 1/4 inches square. There are four mounting holes on the base. Extreme compactness and neatness prevail.

Laminations are of best silicon steel in a strong steel frame. The coils are vacuum impregnated and therefore moisture-proof.

Each transformer has the name "Gold Bond" stamped on it, also the ratio, and has the primary and secondary designated as such, as well as the binding posts marked P, B+, G and F-. Connect the F- post to a C- voltage. For best tonal results at adequate volume, use the 1-to-3 ratio in the first stage and the 1-to-5 in the second stage. If three stages of audio are used, each should have the 1-to-3 ratio.

High plate voltages may be used, with consequent high plate currents, due to the relatively large diameter of wire used.

These transformers are precisely wound, ruggedly made and represent the finest type of workmanship. They are sold on a 5-day money-back guaranty. Order C.O.D.

- Order Cat. GB-1-3 for 1-to-3 ratio.....
- Order Cat. GB-1-5 for 1-to-5 ratio..... **\$1.50 each**

GUARANTY RADIO GOODS CO.  
143 WEST 45TH STREET  
(Just East of Broadway)  
NEW YORK, N. Y.

# NATIONAL

Velvet B Eliminator \$16.13  
180 Volts (220 Tube Free)



Lowest Model National Velvet-B, Type 8520, in handsome crackle finish black metal casing, for use with sets up to and including six tubes. Input 105-120 volts AC, 50 to 60 cycles. Output 180 volts maximum at 35 milliamperes. Three variable output intermediate voltages. (Det., B.F., A.F.). Eliminator has excellent filter system to eliminate hum, including 80 henry choke and 18 mfd. Mershen condenser. No motorboating! (Eliminator Licensed under patents of the Radio Corporation of America and associated companies.)

Guaranty Radio Goods Co.  
143 W. 45TH STREET  
(Just East of Broadway)  
NEW YORK CITY

**FIXED CONDENSERS!**



*Fixed Condenser, Shown Actual Size.*

Dubilier Micon fixed condensers, type 642, removed from receivers, are available at following capacities and prices.

.0001 mfd. ....	10c	.006 .....	20c
.00025 mfd. ....	10c		
.0003 mfd. ....	10c	All are guaranteed	
.00035 mfd. ....	15c	electrically perfect and	
.001 .....	17c	money back if not	
.0015 .....	17c	satisfied within five	
.002 .....	18c	days.	

**GUARANTY RADIO GOODS CO.**  
143 WEST 45TH STREET

**New Junior Model**

**POLO UNIT \$4**

The famous twin magnet principle for double sensitivity, large magnets for great flux, permanently adjusted armature, all are in the new junior model Polo Unit Weight, 2¾ lbs. Stands 150 volts unfiltered. Stands up to 250 push-pull filtered Works any output tube, power or otherwise. Supplied with 10-ft. cord Order unit now. Five-day money-back guarantee Shipped C. O. D. if desired.

**Acoustical Engineering**

**Associates**

143 West 45th Street  
New York City  
(Just East of Broadway)

*Highest Grade  
Key Tubes at  
**Defiant  
Prices!***

**Screen Grid Tubes**

224	at	\$1.43
222	at	1.88

**Power Tubes**

250	at	4.95
210	at	3.25
245	at	1.28
112A	at	.78
171A	at	.78

**Other Tubes**

227	at	.90
226	at	.68
280	at	1.13
281	at	2.95
201A	at	.53

The above constitute the nine most popular tubes used in radio today. Despite the severely low prices the Key tubes are firsts of the very first quality. Besides, there is a five-day money-back guaranty! The above tubes are manufactured under licenses granted by the RCA and its affiliated companies.

All prices are net and represent extreme discount already deducted.

GUARANTY RADIO GOODS CO., 143 West 45th St., N. Y. City. (Just East of Broadway).

Enclosed please find \$..... for which ship at once tubes marked below:

<input type="checkbox"/>	224 AC screen grid .....	\$1.43
<input type="checkbox"/>	245 AC power tube .....	\$1.28
<input type="checkbox"/>	226 AC amplifier .....	.68
<input type="checkbox"/>	227 AC det.-amp. ....	.90
<input type="checkbox"/>	280 AC rectifier .....	\$1.13
<input type="checkbox"/>	222 battery screen grid .....	\$1.88
<input type="checkbox"/>	112A power tube .....	.78
<input type="checkbox"/>	171A power tube .....	.78
<input type="checkbox"/>	201A battery tube .....	.53
<input type="checkbox"/>	250 power tube .....	4.95
<input type="checkbox"/>	210 power tube .....	3.25

Name .....

Address .....

City ..... State .....

Put cross here if C. O. D. shipment is desired.  
Canadian remittance must be by postal or express money order.

**5-Day money-back guaranty**

**MB-29**

AC TUNER — WRITE FOR WHOLESALE PRICES!

**Push-Pull Amplifier**

The National Velvetone Push-Pull Power Amplifier (shown at right) consists of an AC-operated filament-plate supply, with two stage transformer audio amplifier and output transformer built in. Made only for 110-V., 50-60 cycles. Sold only in completely wired form, licensed under RCA patents.

The new Power Amplifier has been developed and built to get the very most out of the MB-29. It is a combination power supply and audio amplifier, using a 280 tube for a rectifier, one stage of transformer audio with a 227 tube and a stage of push pull amplification with two 245s. It furnishes all power for itself and for the MB-29, as well as the audio channel. Order catalog PPPA, list price, completely wired and equipped with phonograph jack, (less tubes) \$97.50. Your price.

**WRITE FOR  
WHOLESALE  
PRICES**

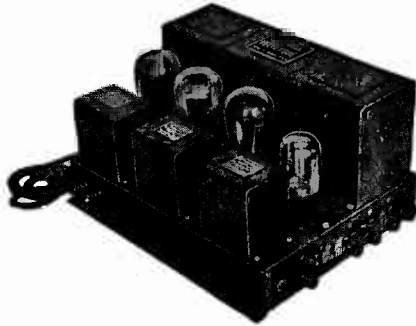

View of National Velvetone Push-Pull Power Amplifier, an expertly made A, B and C supply and audio amplifier producing marvelous tone quality.

**GUARANTY RADIO GOODS CO.**

143 WEST 45TH STREET

NEW YORK CITY

**NEW DRAKE'S ENCYCLOPEDIA**

1,680 Alphabetical Headings from A-battery to Zero Beat; 1,025 Illustrations, 920 Pages, 240 Combinations for Receiver Layouts. Price, \$6.00. Radio World, 145 W. 45th St., N. Y. C

**MICROPHONE LIGHTERS**

For cigars or cigarettes, with button switch at top. Press switch, and lighter acts instantaneously. \$1.00. Model B lighter on tray, \$1.50. Radio World, 145 W. 45th St., N. Y. C.

**Two for the price of One**

Get a FREE one-year subscription for any ONE of these magazines:

- CITIZENS RADIO CALL BOOK AND SCIENTIFIC DIGEST (quarterly, four issues).
- RADIO (monthly, 12 issues; exclusively trade magazine).
- RADIO ENGINEERING (monthly, 12 issues; technical and trade magazine).
- RADIO INDEX (monthly, 12 issues) Stations, programs, etc.
- SCIENCE & INVENTION (monthly, 12 issues; scientific magazine, with some radio technical articles).
- AMERICAN BOY—YOUTH'S COMPANION (monthly, 12 issues; popular magazine).
- BOYS' LIFE (monthly, 12 issues; popular magazine).

Select any one of these magazines and get it FREE for an entire year by sending in a year's subscription for RADIO WORLD at the regular price, \$6.00. Cash in now on this opportunity to get RADIO WORLD WEEKLY, 52 weeks, at the standard price for such subscription, plus a full year's subscription for any ONE of the other enumerated magazines FREE! Put a cross in the square next to the magazine of your choice. In the above list, fill out the coupon below, and mail \$6 check money order or stamps to RADIO WORLD, 145 West 45th Street, New York, N. Y. (Just East of Broadway).

Your Name .....

Your Street Address .....

City ..... State .....

- If renewing an existing or expiring subscription for RADIO WORLD, please put a cross in square at beginning of this sentence.
- If renewing an existing or expiring subscription for other magazine, please put a cross in square at the beginning of this sentence.

**RADIO WORLD, 145 West 45th Street, New York, N. Y. (Just East of Broadway)**

**DOUBLE**

**VALUE!**



Temple AC Dynamic Model 10, in a beautiful cabinet. The speaker chassis is one of the finest made. There are an output transformer and dry rectifier built in. The cabinet has decorated walnut front and back, with carved grille ornament. An AC switch is accessible underneath cabinet. Rear is removable for adjustment of resistor knob to match the impedance of your receiver's output tube. Connect plugged AC cable to 110 volts AC, 50 to 60 cycles, and connect tipped cords to speaker post of receiver. This remarkable speaker Cat. TEM-10 at only.....

**\$15.34**

Send No Money! Order C.O.D. from  
**Accoustical Engineering Associates**  
 143 WEST 45th ST. NEW YORK CITY

**WHAT**

A BARGAIN AT ONLY



**\$4.89!!**

**Ansonia Gothic Speaker, a tremendous bargain at.....\$4.89!**

A loudspeaker that gives you real performance, that stands up to a 171 or 171A tube without requiring an output filter, and that works splendidly from output filters in sets using 210, 245 or 250, single or push-pull, in a genuine walnut cabinet, all at less than the price of a good magnetic unit alone! And the magnetic unit in this Ansonia Speaker is of the very best Ansonia type.

The cabinet is of the popular Gothic type, and is a beauty indeed. Why, the cabinet alone cost the manufacturer in thousand lots more than the price now asked for the complete speaker.

Use this speaker on any set, battery-operated or AC, and you'll be delighted.

GUARANTY RADIO GOODS CO.  
 143 West 45th Street, New York, N. Y.  
 Just East of Broadway

Please ship C. O. D. one Ansonia Gothic magnetic speaker, in genuine walnut cabinet, @ \$4.89 plus post office charges, on 5-day guaranty of quick refund of purchase price if I am not satisfied with speaker for any reason.  
 Please send me a square model (not Gothic), but same unit in square walnut cabinet @ \$4.24.

Name .....

Address .....

City ..... State .....

**5-day Money-Back Guaranty.**

**Short Wave Circuit**



National Thrill Box, 4-tube short wave circuit 15 to 535 meters, battery-operation of filaments; B suscep. either batteries or eliminator.

Get a real kick out of listening to foreign stations on a real short-wave circuit, the National Thrill Box. Uses one 222 screen grid RF amplifier, one 200A detector, one 240 first audio and one 171A or 112A output. Single control. Buy the parts and build the circuit in two hours. Data sheet shows dial settings where foreign stations come in. Cat. SW4EF, all parts, including decorative brown steel cabinet, all six plug-in coils, list price \$51.90 (less tubes). Write for wholesale prices.

**Guaranty Radio Goods Co.**  
 143 West 45th Street New York City  
**TRIAL SUBSCRIPTION, 8 WEEKS, \$1.00.** Send \$1 and we will send you Radio World for 8 weeks, postpaid. **RADIO WORLD, 145 West 45th St., N. Y. City.**

**SEPARATE TESTER COMBINATION**

Consists of two-meter assembly in neat black metal case, with an external high resistance meter. The two meters in the case read (a) 0-20, 0-100 milliamperes; (b) 0-10 volts, AC or DC, same meter reads both. The external high resistance meter reads 0-600 volts, AC or DC (same meter reads both). Thus you can test any plate current up to 100 ma., any filament voltage, AC or DC, up to 10 V., and any plate voltage, or line voltage or other AC or DC voltage, up to 600 volts. Five-prong plug, screen grid cable, and 4-prong adapter included. Order Cat. ST-COMB @.....\$11.00  
 2-meter assembly, cable plugs, Cat. 215 @ \$7.00  
 3-600 AC-DC meter alone, Cat. M600 @ \$4.95

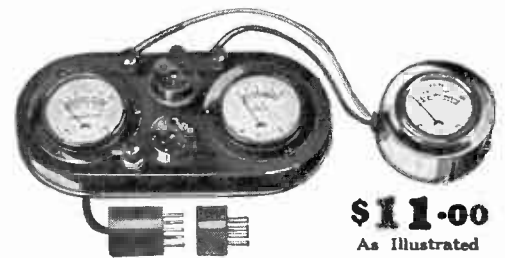

**\$11.00**  
 As Illustrated

Guaranty Radio Goods Co., 143 West 45th St., N. Y. City

**FILL OUT AND MAIL NOW**

SUBSCRIPTION BLANK

**RADIO WORLD**

145 West 45th Street, New York City

RADIO WORLD

Please send me RADIO WORLD for ..... months, for which

SUBSCRIPTION RATES:

Single Copy.....\$ .13  
 Three Months..... 1.50  
 Six Months..... 3.00  
 One Year, 52 Issues..... 6.00  
 Add \$1.00 a Year for Foreign postage; 50c for Canadian Post-

please find enclosed

If this is a renewal, put cross in square at left.

# Long Distance Reception

# Guaranteed!

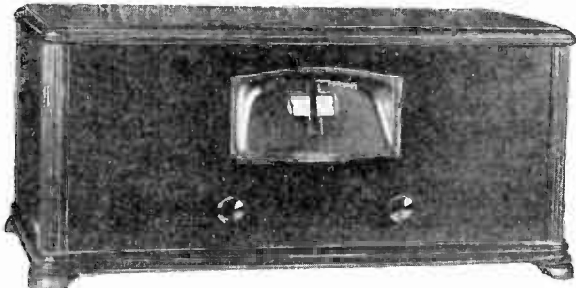

The Balkite A5 neutrodyne. In real walnut table model cabinet by Berkey & Gay. Volume control at left, AC switch at right, drum dial at center, with space to mark in call letters.

You want DX—the more DX the merrier! But why take any chances? We positively guarantee that the Balkite Neutrodyne, made by Giffillan, will get you all the DX you could desire! Try the set for five days. If not completely satisfied, return it in that time for prompt refund of purchase price!

Three stages of tuned RF, neutralized, so there's no squealing; easy tuning; operation on short piece of wire indoors perfectly satisfactory; no repeat tuning points; no hum; phonograph pickup jack built in; excellent tone quality; good selectivity. These are outstanding points of the receiver, ONE OF THE MOST SENSITIVE BROADCAST RECEIVERS EVER DEVELOPED. The receiver alone lists for \$135. Here you get the set, speaker and tubes at \$9.50 less than half the list price of the receiver alone!

## 8-Tube Push-Pull AC Balkite Neutrodyne with Matched Speaker and All Tubes, Complete ..... \$57.50

A good many bargains in radio receivers are available today, because set manufacturers over-produced, and had to let their stock go at sacrifice prices. It does not follow that all sacrificed receivers are worth even the cut price. We turned down many "opportunities" to obtain large quantities of "sacrificed" receivers. When the Balkite was offered to us we tested its performance for five days and were delighted. We took the set apart completely to see what calibre of parts was used and how the wiring was done. When we tell you all the parts were ace-high and the wiring the best we've seen, you will know this is an extraordinary receiver. The tubes used are five 2Z7, two 112A and one 280. The undistorted maximum power output is 780 milliwatts.

The line input must be 50-60 cycles, 105 to 120 volts. There is a voltage adjuster built in. The magnetic speaker has a matched impedance for the output of the receiver, and is itself housed in a real walnut cabinet with marqueterie inlay.

**FIVE-DAY MONEY-BACK GUARANTEE ON RECEIVER, TUBES AND SPEAKER!**

**Guaranty Radio Goods Co., 143 West 45th Street, New York, N. Y.**

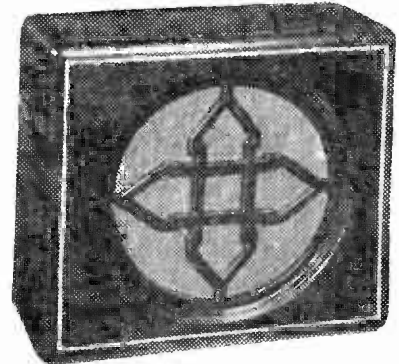

The speaker is of hand-rubbed genuine walnut and its list price alone is \$35.00.

## 0-60,0-300

HIGH RESISTANCE

## DC VOLTMETER

With three 28" tipped leads built in

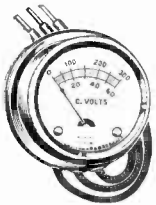

J-246 Voltmeter, for measuring all direct current voltages, including B eliminators. 0-60, 0-300 (double range).

A portable type, high resistance meter, 2 1/2" outside diameter, for close reading of direct current voltages up to 60 volts, and for reading DC voltages up to 300 volts. Three vari-colored 28" insulated leads, with jack tips, are built in. Black is minus, yellow is 0 volts maximum and red is 300 volts maximum. These voltages are marked at the meter outlets. Cat. J-246. Net price, \$2.28.

Multiplier, with jack terminals, to increase range 0-300 range to 0-600. Cat. J-106JT (with jack terminals), net price, \$1.18. Order One C. O. D.

**GUARANTY RADIO GOODS CO.**  
143 West 45th St., N. Y. City

## LACAULT'S BOOK

"Super-Heterodyne Construction and Operation," giving the master's most masterful exposition of the theory, performance and construction of this fascinating type of circuit, is a necessity to every serious radio experimenter. More than 100 pages and more than 50 illustrations. Buckram cover. This book by R. E. Lacault. FREE if you send \$1.00 for an 8-weeks subscription for Radio World. Present subscribers may accept this offer. Subscription will be extended.

**RADIO WORLD** 145 W. 45th St., N. Y. City  
Just East of B'way

## RADIO WORLD and "RADIO NEWS"

BOTH FOR ONE YEAR @ \$7.00

You can obtain the two leading radio technical magazines that cater to experimenters, service men and students the first and only national radio weekly and the leading monthly, for one year each, at a saving of \$1.60. The regular mail subscription rate for Radio World for one year, a new and fascinating copy each week for 52 weeks is \$6.00. Send in \$1.00 extra, get "Radio News" also for a year—a new issue each month for twelve months Total, 64 issues for \$7.00.

☐ If renewing Radio World subscription, put cross square. **RADIO WORLD, 145 West 45th Street, New York, N. Y.**

## RADIO WORLD'S QUICK-ACTION CLASSIFIED ADS

10 CENTS A WORD  
10 WORDS MINIMUM  
CASH WITH ORDER

## NEW Morecroft

"Elements of Radio Communication" by Prof. John H. Morecroft, of the Engineering Department of Columbia University, is the latest book on radio by this outstanding authority.

This book is entirely new and contains matter which never before has been published. It is written in plain language so that every radio novice can understand it, yet it is a complete course in the elements of radio.

It contains 266 pages, 170 illustrations and a complete index. Price \$3.00.

**RADIO WORLD**  
145 West 45th St., New York, N. Y.

## CONE ASSEMBLY WITH DOUBLE MAGNET UNIT

\$4.95



All assembled, with long cord, ready to play, Shipping weight 6 lbs. \$4.95 (Cat. CAS) Net

**Guaranty Radio Goods Co.**  
145 West 45th St., New York City

## LOOK AT YOUR WRAPPER

You will see by the date thereon when your subscription for Radio World expires. If the subscription is about to run out, please send us renewal so that you will not miss any copies. Subscription Department, RADIO WORLD, 145 West 45th St., N. Y. City.

## PUBLISHERS CAN SUPPLY ALL 1929 COPIES OF RADIO WORLD

Excepting issues of Jan. 5, Feb. 23, and May 11

If you have missed any copies of Radio World for the year 1929 and want to complete your file, let us know what issues you are short and we will mail what we can at 15c a copy, or any seven issues for \$1.00, mailed postpaid.

Circulation Dept., Radio World, 145 W. 45th St., N. Y. City.

## LYNCH RESISTORS

For POWER circuits where ordinary resistors are impractical, use the Dynohmic Resistance. 3. watt size, 85. 2.5 watt size, \$1.00.

**ARTHUR H. LYNCH, INC.**  
1775 Broadway New York City  
Send for free book on Resistance in Radio

# MICROPHONE LIGHTERS

for cigars or cigarettes, with button switch at top. Press the switch and light up!

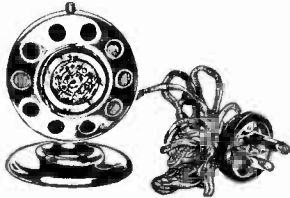

Model A lighter, microphone design, with 5-ft. AC cable and plug. Works on 110 volts, AC any frequency and on direct current. Price \$1.80



Model B lighter, microphone design, on tray, with 5-ft AC cable and plug. Works on 110 volt AC, any frequency, and on direct current. Exactly the same lighter as the other, only tray is added. Price \$1.50

This lighter is instantaneous. Hold button down only long enough to light a cigar or cigarette. The two models are furnished in attractive sprayed finish. Both are very compact! For instance, the tray is only 4 1/2" in diameter. Use these lighters in your home and for holiday gifts.

The heater element is renewable. Price 35 cents.

RADIO WORLD, 145 West 45th St., N. Y. City  
 Please send me Model A Microphone Lighter at \$1.80  
 Please send me Model B at \$1.50.  
 Please ship C. O. D.

Name .....

Address .....

City..... State.....

## SUBSCRIBERS!

### Look at the Expiration Date on Your Wrapper

Please look at the subscription date stamped on your last wrapper, and if that date indicates that your subscription is about to expire, please send remittance to cover your renewal.

In this way you will get your copies without interruption and keep your file complete.

SUBSCRIPTION DEPARTMENT  
**RADIO WORLD**  
 145 WEST 45TH ST., N. Y. CITY

# CUSTOM-RADIO

## At Its Best In the News



### Battery Operated Receiver

**POWER**, selectivity, tone beyond all expectation; refinement of components, unknown in factory-built sets—feature all of the famous "HiQ-30" models—Battery; D. C. and A. C.

Utilizes the remarkably efficient three-stage tuned Band Filter, designed and used solely by Hammarlund, provides absolute 10-kilocycle separation of stations throughout the broadcast band—without side band cutting.

Three screen-grid tubes, utilized to maximum efficiency, give tremendous R. F. amplification and distance range. Push-pull audio amplifier gives great volume with a rich, vibrant tone hitherto unknown to battery-operated receivers.

Build the "HiQ-30" for your own use—in the cabinet of your choice. Get the "HiQ-30" facts today—Send 25c to Dept. RW-45 for the 48 page "HiQ-30" Manual.

List price, Battery-Operated chassis (all parts less tubes), \$139.50. Choice of specially selected cabinets including phono-combinations. All-electric D. C. and A. C. models up to \$1175.

**Hammarlund-Roberts, Inc.**  
424-438 W. 33rd St., New York

**NEW DRAKE'S ENCYCLOPEDIA**—1,680. Alphabetical Headings from A-battery to Zero Beat. 1,025 Illustrations, 920 Pages, 240 Combinations for Receiver Layouts. Price, \$6.00. Radio World, 124 W. 45th St., N. Y. C.

**LOFTIN-WHITE**  
Direct-Coupled  
**AMPLIFIER**  
with the ELECTRAD KIT  
Approved by the Designers  
175 Varick St., New York, N. Y.

**ELECTRAD**

RW 45

## DX!

### with the Find-All Screen Grid FOUR

Here is the outstanding circuit for performance on four tubes—one 222, two 201A and one 171A. It works as well with batteries or A and B eliminators. This is the circuit described in March 15th Radio World, by Adam J. Arlington. We have letters from builders who got European stations on this set at loudspeaker volume. It is a DX marvel. It is for broadcast waves, remember; not short waves!

Complete unwired kit (less cabinet, tubes and speaker) ..... **\$25.00**

Wired Model (includes cabinet) .... **\$35.00**

**FIND-ALL RADIO CO.**  
Suite 707—285 Madison Ave.,  
Dept. RW-45 N. Y. CITY

## New Multi-Tap Voltage Divider

3,000	3,000	2,000	2,000	2,000	800	700
-------	-------	-------	-------	-------	-----	-----

0	50	50	100	200	400	450	500	550	600	650
---	----	----	-----	-----	-----	-----	-----	-----	-----	-----

The resistance values between the twenty taps of the new Multi-Tap Voltage Divider are given above. The total is 17,100 ohms and affords nineteen different voltages.

**THE** Multi-Tap Voltage Divider consists of two rugged, expertly engineered wire-wound, enamelled resistors, mounted in series, one atop the other, with twenty lugs, providing all necessary choice of voltages without the uncertainty of adjustable variable resistance.

The Multi-Tap Voltage Divider has a total resistance value of 17,100 ohms, of which 3,600 ohms are on the lower bank and 13,500 on the upper bank. Without the zero voltage lug (at lower left) the total number of useful lugs is nineteen. The resistance stated are those between respective lugs and are to be added together to constitute 17,100 ohms total.

The unit is serviceable in all installations where the total current drain does not exceed 100 milliamperes.

Extreme care has been exercised in the manufacture of the Multi-Tap Voltage Divider. It is mounted on brackets insulated from the resistance wire that afford horizontal mounting of the unit on baseboards and subpanels.

There long has been a need for obtaining any necessary intermediate voltage, including all blasing voltages, from a Multi-Tap Voltage Divider, but each lug has to be put on individually by hand, and soldered, so that manufacturing difficulties have left the market barren of such a device until now.

The Multi-Tap Voltage Divider is useful in all circuits, including push-pull and single-sided ones, where the current rating of 100 milliamperes is not seriously exceeded and the maximum voltage is not more than 400 volts. If good ventilation is provided, this rating may be exceeded 20 per cent.

The expertness of design and construction will be appreciated by those whose knowledge teaches them to appreciate parts finely made.

When the Multi-Tap Voltage Divider is placed across the filtered output of a B supply which serves a receiver, the voltages are in proportion to the current flowing through the various resistances. By making connection of grid returns to ground, the lower voltages may be used for negative bias by connecting filament center, or, in 227 and 224 tubes, cathode to a higher voltage.

If push-push is used, the current in the blasing section is almost doubled, so the midtap of the power tubes' filament winding would go to a lug about half way down on the lower bank.

Order Cat. MTVD at \$3.95.

---

Guaranty Radio Goods Co.,  
143 W. 45th St., New York City.  
(Just East of Broadway.)

Please send C.O.D. one Multi-Tap Voltage Divider.  
Total resistance, 17,100 ohms; twenty taps.

Name .....

Address .....

City..... State.....

### Spring Action Diagonal Nipper



A DIAGONAL cutting nipper is the second most useful tool for radio work, next to the soldering iron. Non friction spring action adds convenience of use, as the handles are sprung back just far enough for a comfortable grip, and the jaws are closed by easy pressure or the handles.

For cutting wire, a constant operation in your work this tool is most serviceable, as it makes a clean cut, right through fuzzy insulation as well as through metal. The cut is far more incisive than with the common diagonal cutting pliers. With the diagonal nipper you can cut wire not only along its length, but wherever it may be attached, since accessibility is perfect. A cut can be made any place where the diagonal nipper can enter, since the cutting can be done at the tip. Pliers with diagonal cutters can only pry, not cut, at the extremity.

With the diagonal nipper insulation can be bared from wire ends for soldering. Also screws up to 8/32 machine screw used in radio can be nipped off at any point with one firm application of pressure with one hand.

The device is used extensively in radio set factories and by custom set builders and radio experimenters.

Size 5 1/2" long; weight 1 1/2 lbs.; material, drop forged steel; finish, nickel plated.

Send \$3.00 for 6 months' subscription for Radio World and ask for No. 177 Nipper, free, RADIO WORLD, 145 West 45th Street, New York, N. Y.

Put cross here if renewing subscription.

#### SUBSCRIBE NOW!

RADIO WORLD, 145 West 45th St., New York City. Enclosed please find my remittance for subscription for RADIO WORLD, one copy each week for specified period:

- \$6 for one year, 52 issues.
- \$3 for six months, 26 issues.
- \$1.50 for three months, 13 issues.
- This is a renewal of an existing mail subscription (Check off if true).

Your name .....

Address .....

City .....

### BROADWAY-HOLLYWOOD

World's most intriguing places. Where famous stage, screen, radio stars live their lives. Intimate stories of their stage and personal doings in

NEW YORK STAR National Illustrated Amusement Weekly

Edited by Roland Burke Hennessy. Clever writer-cover comedy, tragedy, fascination of professional life. Portraits and unusual pictures of favorites. 10c copy. \$5 year (52 issues). SPECIAL: 12 issues \$1. STAR, 1562 Broadway, New York.

# Nothing Finer Than This Dynamic in Tone Quality!

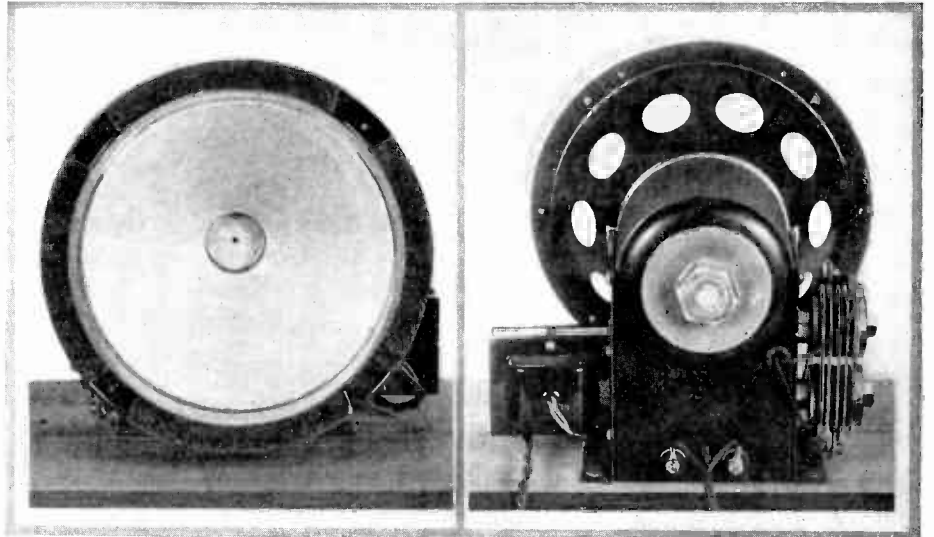

### Try This AC Dynamic Erla—No Matter on What Set and You Will Verify These Facts: Tone Unexcelled, sensitivity most remarkable

TO WORK this speaker, put plug into AC wall socket, lamp socket or convenience outlet of set, connect speaker tips to output posts of set, and tune in.

- Here are the technical data on the AC dynamic Erla:
- 10 feet long power leads with plug
- 10 feet long speaker leads with one-inch terminal tips
- Outside diameter of cone, 9 inches
- Depth of speaker, 8 inches
- Overall width of speaker, 9.5 inches
- Mounting board, detachable, 10 1/4 x 12 1/4 x 1/8 inches
- Burtex cone
- Diameter of central magnet pole, 1.5 inches
- Flexible spring mounting of tip of cone, and moving coil
- Moving coil accurately center-mounted
- Depth of magnet structure, 4.5 inches
- Outside diameter of magnet structure, 4.5 inches
- Built-in full-wave Westinghouse Rectox dry rectifier
- Husky output transformer built in; heavy core, shielded
- Superior workmanship
- Thick felt buffers on front of cone edges
- Built-in power transformer for rectifier
- Will stand output of 250 tubes in push-pull and work superbly in any tubes, single or push-pull
- Tone quality is unsurpassed

# \$12.50

### Our Guaranty!

We have had considerable experience with AC dynamic chassis, and it is our firm conviction this is the best one we have offered so far.

So convinced are we that you will be overjoyed from the reproduction afforded by this Erla chassis that we ask you to buy it at no risk to yourself whatsoever. Order one shipped C.O.D. Try it for five days. If for any reason you desire to return it in that time, do so and we will refund your purchase price and expressage you laid out. This widest guaranty applies only to the Erla chassis.

Acoustical Engineering Associates  
143 West 45th Street New York, N. Y.  
Please ship at once, express C.O.D., one Erla dynamic chassis, 110 volt AC, 50-60 cycles, as advertised, at \$12.50, on a five-day guaranty or money-back if not completely satisfied, including cartage money, which applies to the Erla offer only.

Name .....

Address .....

City ..... State .....

#### PLEASE GIVE US TWO WEEKS

for changing your address, showing new renewal expiration date, etc. Subscription orders are arriving in such large numbers that it takes two weeks to effectuate the change. RADIO WORLD, 145 West 45th St., N. Y. City.

#### RADIO WORLD'S BOOK SERVICE

has been found of great value not only by radio fans, constructors, etc., but also by radio and other technical schools throughout the country. See the radio books advertisements in this issue.

# Quick Action Classified Ads

## Radio World's Speedy Medium for Enterprise and Sales

10 cents a word — 10 words minimum — Cash with Order

**ARISTOCRAT FLOOR SPEAKER**—With Molded Wood Horn and Horn Motor built in. Great value. \$14.00. Acoustical Engineering Associates, 143 W. 45th St., N. Y. C.

**"EVERYBODY'S AVIATION GUIDE."** By Maj. Page. \$2 postpaid. Also "Modern Aircraft" by same author. \$5. postpaid. Radio World, 145 W. 45th St., N. Y. City.

**LACAULT'S BOOK.** "Superheterodyne Construction and Operation." and Radio World for 8 weeks for \$1. Radio World, 145 W. 45th St., N. Y. City.

**"MATHEMATICS OF RADIO."**—A great help to everybody interested in radio. \$2 postpaid. Radio World, 145 W. 45th St., N. Y. City.

**CUSTOM-BUILT SETS:** Loftin-White Amplifier \$30. MB29 \$55. S-M 712 Tuner \$55. All makes. Complete list free. J. T. Boyer, Jr., 853 Piedmont Ave., Winston-Salem, N. C.

**ULTRADYNE** and Hi-Q 30 cheap. F. L. Hanson, Iliou, N. Y.

**OUTDOOR WORK**—Get outdoor government job; \$1680 year. Patrol forests; protect game. Write for details. Bradley Inst., All, Denver, Colo.

**TWO FOR ONE.** Radio World for 52 weeks and Radio News twelve months at the combination rate of \$7. Radio World, 145 W. 45th St., N. Y. City.

**RADIOMEN: TRY FURMHOLD** liquid soldering flux for cleanest joints you ever saw. Noncorrosive. Solder sticks instantly. No coaxing. Big bottle \$1. Sample, 50c. Guaranteed. Furmhold Co., 109-24 208th St., Bellerose, N. Y.

**"FORD MODEL 'A' CAR."** Its Construction, Operation and Repair, By Victor W. Page, M.E. 545 Pages, 251 Specially Made Engravings. \$2. postpaid. Radio World, 145 W. 45th St., N. Y. City.

**"AUDIO POWER AMPLIFIERS,"** by J. E. Anderson and Herman Bernard, the first and only book on the subject. \$3.50. Hennessy Radio Publications Corporation, 145 West 45th St., N. Y. City.

## High Efficiency Tuning Coils



Wound with non-insulated wire plated with genuine silver, on grooved forms, these coils afford high efficiency because of the low resistance that silver has to radio frequencies. The grooves in the moulded bakelite forms insure accurate space winding, thus reducing the distributed capacity, and keep the number of turns and separation constant. Hence the secondary reactances are identical and ideal for gang tuning.

The radio frequency transformer may be perpendicularly or horizontally mounted, and has braced holes for that purpose. It has a center-tapped primary, so that it may be used as antenna coil with half or all the primary in circuit, or as interstage coupler, with all the primary on a screen grid plate circuit, or half the primary for any other type tubes, including pentodes.

The three-circuit tuner has a center-tapped primary, also. This tuner is of the single hole panel mount, but may be mounted on a chassis, if preferred, by using the braced holes.

The secondaries are for .0005 mfd. tuning only. There are no models for .00035 mfd.

These coils are excellent indeed for popular circuits like the Diamond of the Air and tuned radio frequency.

Diameters of form, 3 inches.

Two-winding coil, order Cat. GRF @ 99c.

Three-winding coil, order Cat. G-3 CT @ \$1.49.

**GUARANTY RADIO GOODS CO.**  
145 West 45th St., N. Y. City  
(Just East of Broadway)

Please mail me C.O.D. at stated prices, plus few cents extra for postage, the following coils on 5-day money-back guaranty:

GRF @ 99c.

G3CT @ \$1.49

Name .....  
Address .....  
City ..... State .....

## O-1 MA, \$5.95

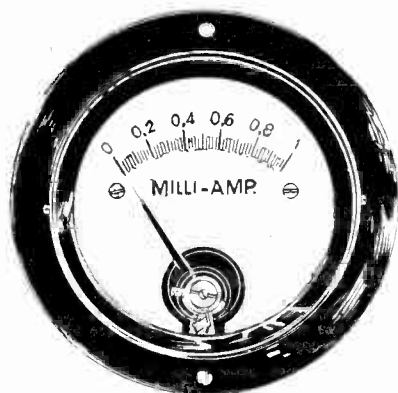

Here is a 0-1 milliammeter, accurate to plus or minus 1%, clearly legible to two-one hundredths of a milliampere at any reading (20 microamperes). This expertly made precision instrument is offered at the lowest price so far for a 0-1 ma. Order Cat. FO-1 at \$5.95. C. O. D.

**Guaranty Radio Goods Co.**  
143 West 45th Street,  
New York City

**ARISTOCRAT FLOOR SPEAKER**  
With Molded Wood Horn and Horn Motor built in. Good value. \$12.00.  
Acoustical Engineering Associates, 143 W 45th St., N. Y. C.

# 115 Circuit Diagrams of Latest Commercial Receivers and Power Supplies

**S**CHEMATIC diagrams of the latest factory-made receivers, giving the manufacturer's name and model number on each diagram, are now obtainable for the first time—including the most important screen grid receivers. These diagrams were collated by John F. Rider, author of "Trouble Shooter's Manual." The 115 diagrams, each in black and white on sheets 8½ x 11 inches, constitute a supplement to the diagrams contained in "Trouble Shooter's Manual."

There is no duplication of the diagrams that appear in the "Manual." The 115 diagrams are additional and being up-to-date the diagram presentation started in the "Manual."

## All Owners of "Manual" Need These Diagrams

**Y**OU triple the value of "Trouble Shooter's Manual" by getting these 115 new diagrams of latest receivers and power supplies. Every service man needs all the diagrams he can get. Here is the list of 115 diagrams, known as Catalog SP-No. 1:

- Audiola 30B and 7330 Screen Grid
- Balkite Model F
- Crosley 41A, 42 A.C.
- Crosley 609, 610 A.C.
- Crosley 20, 21, 22 screen grid
- Crosley 30S, 31S, 33S screen grid
- Crosley 804 A.C.
- Crosley, 40S, 41S, 42S, 82S screen grid
- Crosley 60S, 61S, 62S screen grid
- Sonora Electric phonograph 7P
- Sonora A30, A32
- Sonora B31 screen grid
- Sonora A36 Sonora A40 Sonora A44
- Kennedy royal 80 Kennedy model 10
- Kennedy model 20 screen grid
- Stewart-Warner 900 A.C.
- Stewart-Warner 950 battery screen grid
- Stewart-Warner 950 A.C. screen grid
- Stewart-Warner 950 D.C. screen grid
- Automatic Electric model B screen grid
- Radiola 44 screen grid
- Radiola 47 screen grid Radiola 66
- Majestic 90
- Majestic 9P6 power unit
- Majestic 9P3 power unit
- Stromberg-Carlson 641 screen grid
- Stromberg-Carlson 642 screen grid
- Stromberg-Carlson 846 screen grid
- Edison R1, R2 and C2
- Edison R1, R2 and C2 (25 cycles)
- Edison R4, R5 and C4
- Parts list for Edison R4, R5 and C4
- Edison C1
- American Bosch 54 D.C. screen grid
- Victor R32 and RE45
- Grebe SK 4 A.C. screen grid (early model)
- Grebe SK 4 A.C. screen grid (late model)
- Grebe SK 4 D.C. screen grid
- Grebe 42R DeLux console
- Traveler A.C. power pack
- Erla 224 A.C. screen grid
- Silver-Marshall 30R screen grid
- Silver-Marshall 30C screen grid
- Silver-Marshall 30D screen grid
- Silver-Marshall 30E screen grid
- Eveready 1, 2, and 3 Eveready series 30
- Eveready series 40
- Eveready series 50 screen grid
- Steinite 40, 50 and 102 Steinite 50 power unit
- All American Mohawk 96 screen grid (60 cycle)
- All American Mohawk 90 (25 cycle)
- All American Mohawk 90 (60 cycle)
- All American Mohawk 70, 73 and 75
- Gulbranson Model C (early model)
- Gulbranson Model C (late model)
- Bremer-Tully 7-70 and 7-71
- Bremer-Tully R1 and R2
- Earl 21, 22 Earl 31, 32 Earl 41, 42
- Philco 65 screen grid Philco 76 screen grid Philco 87
- Philco 95 screen grid
- Peerless Electrostatic series, screen grid
- Fada 20 and 20Z Fada 22 battery
- Fada 25 and 25Z screen grid
- Fada 25 and 25Z screen grid with M250 and M250Z Electro units
- Fada 35 and 35Z screen grid Fada 75 and 77 screen grid
- Brunswick 5 NCB Radio Chassis Schematic
- Brunswick 5 NCB Audio Chassis Schematic
- Brunswick 5 NCB and 3 NCB Audio Chassis Schematic
- Brunswick 5 NCB cabinet wiring
- Brunswick 3 NCB Radio Chassis Schematic
- Brunswick 3 NCB cabinet wiring
- Brunswick S14, S21, S31, S81, S82 screen grid Radio Chassis Schematic
- Brunswick S14, S21, S31, S81, S82 screen grid Radio Chassis Actual
- Brunswick S14, S21, S81, S82 Audio Chassis Schematic (25 cycle)
- Brunswick S14, S21, S81, S82 Audio Chassis Schematic (60 cycle)
- Brunswick S14, S21, S81, S82 Audio Chassis Actual (25 cycle)
- Brunswick S14, S21, S81, S82 Audio Chassis Actual (60 cycle)
- Brunswick S31, Audio Chassis Schematic (60 cycle)
- Brunswick S31 Audio Chassis Actual (60 cycle)
- Brunswick 3 KR8 cabinet wiring
- Brunswick 3 KR8 Radio Chassis
- Brunswick 3 KR8 Audio Chassis Schematic
- Brunswick 3 KR8 Audio Chassis Actual
- Brunswick 5 NO Radio Chassis Schematic
- Brunswick 5 NO Socket Power Schematic
- Brunswick 5 NO Socket Power Actual
- Brunswick 3 KR0 and 3 KR6 Radio Chassis
- Brunswick 3 KR0 and 3 KR6 Socket Power
- Brunswick 5KR, 5KR0, 2KR0 Socket Power
- Brunswick 5KR, 5KR0, 3KR0, 2KR0, 5KR6 Socket Power
- Brunswick 5KR, 5KR0, 2KR0, 5KR6 Radio Chassis
- Amrad Bel-Canto series
- Sparton 89, Sparton 89A, Sparton 49
- Sparton ensemble
- Sparton 931, 301 D.C., Sparton 931 A.C.
- Sparton 110 A.C., Sparton 301 A.C.

Here is an opportunity to obtain these hard-to-get wiring diagrams of modern radio receivers. The sheets are punched with three standard holes for loose-leaf binding. Each diagram is on a separate page. As you will see by glancing through the above list, these diagrams include the popular receivers of the day. Electrical constants are indicated on the majority of the diagrams and in many cases the actual chassis layouts are shown with color coding.

These schematics will save you a good deal of time. No more tracing circuits! The diagrams are a necessary part of your working equipment.

We cannot offer individual drawings. Please use coupon below.

Subscribe for RADIO WORLD for six months at the regular price, \$3.00, and have these diagrams delivered to you free! No other premium with this \$3.00 offer!

**RADIO WORLD, 145 West 45th Street, New York, N. Y.**  
Just East of Broadway.

- Enclosed find \$3.00 for which send me RADIO WORLD for six months (26 issues, one each week for 26 weeks) and as a premium send me postpaid, FREE, Cat. SPK No. 1, consisting of 115 separate diagrams, compiled by John F. Rider, as listed in your advertisement.
- Enclosed find \$6.00 for which send me RADIO WORLD for one year (52 issues) and as a premium send Rider's "Trouble Shooter's Manual" free.
- Enclosed find \$9.00. Send me RADIO WORLD for a year and a half (78 issues) and send both of above premiums free.
- This is a renewal of an existing subscription. (Put cross in square, if true.)

Name .....  
Address .....  
City ..... State .....

# NEW J-245-X TROUBLE-SHOOTING JIFFY TESTER

*Illumination Continuity and Polarity Tester FREE with Each Outfit!*

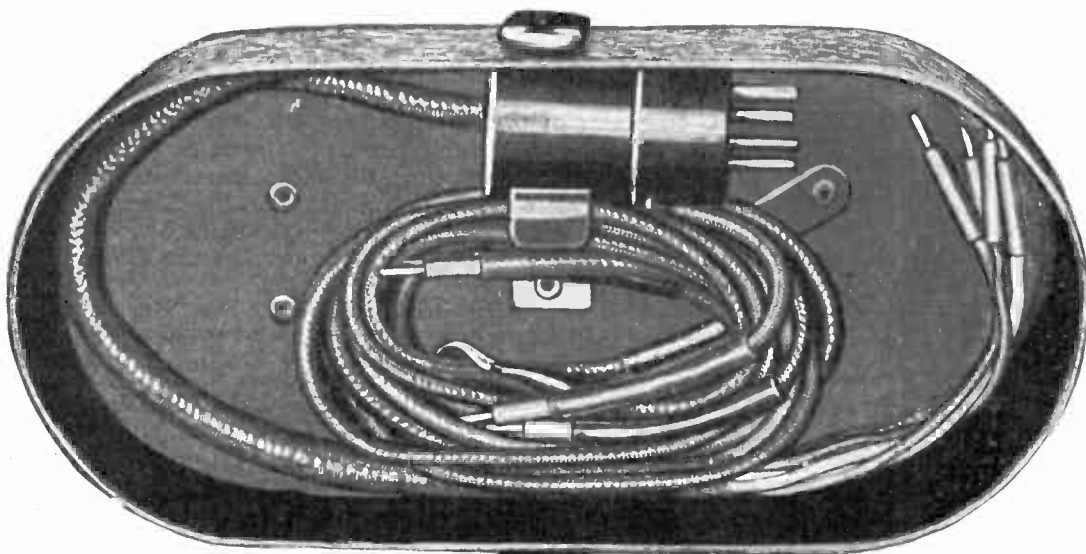

Your Price  
**\$15.82**

Complete

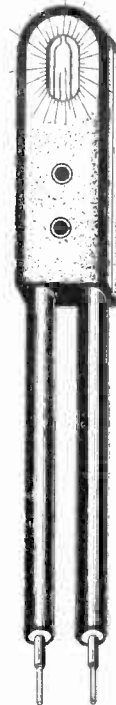
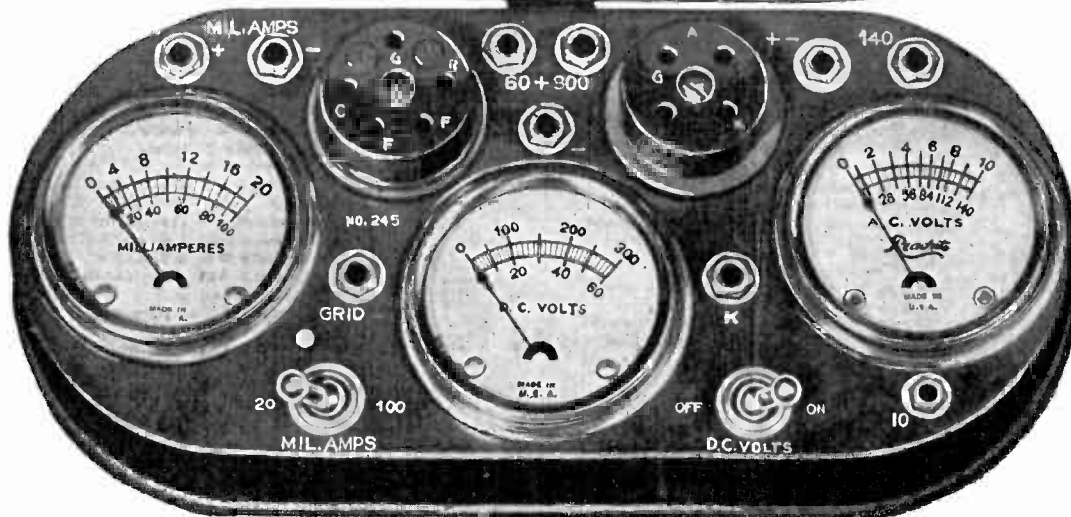

Illumination Tester. Vest Pocket Size. Shows Shorts and Opens Visually, also Polarity of DC line. A Neon lamp is built in.



The three-meter assembly, in the crackle-brown finish carrying case, with slip-on cover in glass. The handle is genuine leather. The buckled strap holds the cover on.



Illustration above is 2/3 scale.

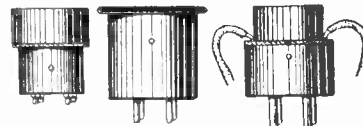

J-111 Multiplier, upper left, with tip; below it, J-106 Multiplier with tip; plugs, left to right. J-19 conforms UV socket to UX plug; J-20, conforms UX tester socket to UV199 tube; J-24, to test Kellogg and old style Arcturus tubes.

## Makes All Necessary Tests in a Jiffy and Simplifies Service Work!

**T**HE new Jiffy Tester, J-245-X, is a complete servicing outfit. It consists of a three-meter assembly in a metal case, with slip-on cover and a cable plug. There are ten adapters. It is vital to have the complete outfit so you can meet any emergency.

With this outfit you plug the cable into a vacated socket of a receiver, putting the removed tube in the tester, and using the receiver's power for making these tests: plate current, up to 100 milliamperes; plate voltage up to 300 volts; filament or heater voltage (AC or DC), up to 10 volts.

Each meter may be used independently. One of the adapters—a pair of test leads, one red, the other black, with tip jack terminals—serves this purpose. Multiplier J-106 extends the range of the DC voltmeter to 600 volts, but this reading must be obtained independently, as most readings on the 0-60 scale of the DC voltmeter. Independent reading of the AC voltmeter for line of voltage is necessary; also to use 0-140 scale while Multiplier J-111 extends the AC scale to 560 volts for reading power transformer secondaries.

The other adapters permit the testing of special receiver tubes, so that tests may be made, in all of 22 different tubes: 201A, 200A, UX199, UV199, 120, 240, 171, 171A, 112, 112A, 245, 224, 222, 223, 280, 281, 227, 226, 210, 250, Kellogg tubes and old style Arcturus tubes.

**W**HEN servicing a radio set, power amplifier, speech amplifier or sound reproduction or recording equipment, the circuits and voltages are almost inaccessible, unless a plug-in tester is used.

The Jiffy 245-X plugs in and does everything you want done. It consists of:

- (1)—The encased three-meter assembly, with 4-prong (UX) and 5-prong (UY) sockets built in; changeover switch built in, from 0-20 to 0-100 ma.; ten vari-colored jacks, five of them to receive the vari-colored tipped ends of the plug cable; grid push-button, that when pushed in connects grid direct to the cathode for 224 and 227 tubes, to note change in plate current, and thus shorts the signal input.
- (2)—4-prong adapter for 5-prong plug of cable.
- (3)—Screen grid cable for testing screen grid tubes.
- (4)—Pair of Test Leads for individual use of meters.
- (5)—J-106 Multiplier, to make 0-300 DC read 0-600.
- (6)—J-111 Multiplier, to make 0-140 AC read 0-560.
- (7)—Two jack tips to facilitate connection of multipliers to jacks in tester.
- (8), (9), (10)—Three adapters so UV199 and Kellogg tubes may be tested.
- (11)—Illumination Tester.

The illumination tester will disclose continuities and opens and also the polarity of DC house mains. It is as handy as a pencil and fits in your vest pocket. It works on voltages from 100 to 400. There are two electrodes in a Neon lamp in the top of the instrument. On AC both electrodes light. On DC only one lights, and that one is negative of the line, the light being on the same side as the lead. Hence the illuminator shows whether tested source is AC or DC, and if DC, which side is negative.

Even the output of the speaker cord will show a light. Also, the device will test which fuses are blown in fused house lines, AC or DC. Besides it tests ignition of spark plugs of automobiles, boats and airplanes, also faulty or weak spark plugs.

Just flash on the illumination tester momentarily. It will last about 4,000 flashes.

GUARANTY RADIO GOODS CO.  
143 West 45th Street, Just East of Broadway,  
N. Y. City.

Please send me on 5-day money-back guaranty your J-245-X Jiffy Tester, complete, with all 10 adapters, and with illuminated Tester FREE with each order. Also send instruction sheet, tube data sheet and rectifier tube testing information.

Please ship C. O. D. @ \$15.82 plus cartage and P. O. fee.

NAME .....

ADDRESS .....

CITY ..... STATE .....

5-DAY MONEY-BACK GUARANTY